



BREL HOME Catalogue 2023



BREL HOME

Valid until further notice - Gross prices excl. VAT



Catalogue contents

Bi-directional motors	6
Solar motors	38
Pleated blinds motors	46
Project motors	54
Curtain track motors	62
Standard motors	68
Motorhead drawings	82
Remote controls	86
Luxury remote controls	88
Standard remote controls	90
Basic remote controls	92
Other controls	93
Accessories	96
Power supply USB	98
Power supply JST	100
Power supply DIN	102
Solar panels	105
Other power supply	106
Crown and Wheels + customized crown and wheels	108
Motorbrackets	118
Other accessories	121
Smart Home Solutions	126
Protocol	130
Warrenty	131
Calculation tool	132
Shipping	134
Terms and conditions	136



Bi-directional motors

BJE24S	8
BJE24D	9
BJE24DD	10
BJE24TD	12
BJE24TR	14
BJE24Q	16
BTE50	18
BLE15	20
BLE20	21
BLE25	22
BPE25	23
BPE25DD	23
BLEQ28	24
BPEQ28	25
BLEQ35	26
BLE35	27
BCE35	28
BEQ35	30
BEQ35DD	30
BR35	31
BEK45	32
BR45	33
BRE45	34
BZE45	35
BLE45	36





BJE24S

24mm 12V electronic radio motor single shaft with JST plug



- ⤴ Electronic limit setting

⤴ Built-in receiver

⤴ Dot-move function

⤴ Preference position / third limit

⤴ Automatic power off switch
- ⤴ Backlash compensation for axis

⤴ Theoretical runtime motor, fully charged battery (DC-1201) and maximum power: 95 min

⤴ Theoretical runtime motor, fully charged battery (DC-1277) and maximum power: 280 min

TECHNICAL SPECIFICATIONS

Articlecode	Torque (Nm)	Speed (RPM)	Diameter (MM)	Motor Length (MM)	Cable Length (CM)	Power (W)	Current (A)	Tension (V)	Water Resistance	Price (€)
BJE24S-0.6	0.6	34	24	129	30	6.4	0.56	12	IP20	€109,50

Controls

Product	Article code	Description	Price
	THB3015	Remote control 15 channels	€51,10
	DD-2712	Remote control Tilt & Lift 15 channels	€39,50
	DD-1873	Wall remote 15 channels	€45,10
	DD-1554	BREL HOME Hub USB WiFi dongle bi-directional	€120,-
	HUB-03	BREL HOME HUB WiFi UTP/PoE	€165,-

Accessories

Product	Article code	Description	Price
	Z-43-001	Three-way plug JST	€3,70
	Z-43-025 / 050 / 100 / 200 / 500	Extension cable with JST plugs	From €6,50
	DC-1201	12V Li-ion 950 mAh battery with 1x DIN 1x JST	€27,50
	DC-1277	12V Li-ion 2600 mAh battery with 1x DIN 1x JST	€52,50
	DC-212	Charger 12V DIN EU style	€19,90

BJE24D

24mm 12V electronic radio motor double shaft with JST plug







- ⤴ Electronic limit setting**
- ⤴ Backlash compensation for axis**
- ⤴ Built-in receiver**
- ⤴ Theoretical runtime motor, fully charged battery (DC-1201) and maximum power: 60 min**
- ⤴ Dot-move function**
- ⤴ Theoretical runtime motor, fully charged battery (DC-1277) and maximum power: 180 min**
- ⤴ Preference position / third limit**
-
- ⤴ Automatic power off switch**

TECHNICAL SPECIFICATIONS

Articlecode	Torque (Nm)	Speed (RPM)	Diameter (MM)	Motor Length (MM)	Cable Length (CM)	Power (W)	Current (A)	Tension (V)	Water Resistance	Price (€)
BJE24D-0.8	0.8	34	24	210	30	10	0.83	12	IP20	€119,50

Crown and Wheels

Product	Article code	Description	Price
	DC-213	Charger 12V DIN UK style	€19,90
	DC-232W	Transformer 12V 5A EU with JST plug	€32,50
	V4K5	Reducer 4k5	10 st. €3,85
	V-HD-R5	Reducer 4k5 for HD	10 st. €4,55
	V6K6	Reducer 6k6	10 st. €3,85

Motorbrackets

Product	Article code	Description	Price
	V4K5-VA	Reducer 4k5 Vako	10 st. €4,30
	Z-75	Fixation for shaft	€0,85
	Z-75-4K5	Fixation for shaft 4k5	10 st. €4,65
	BP-24	Fixation bracket motor HD VB/PB headrail	€1,05
	BP-VA	Fixation bracket Vako 20.04/ Coulis-se/ Heditex-Valencia	10 st. €4,30

BJE24DD

24mm 12V electronic radio motor double shaft and double wired with JST plug



- ⬆ Electronic limit setting

⬆ Built-in receiver

⬆ Dot-move function

⬆ Preference position / third limit

⬆ Automatic power off switch
- ⬆ Backlash compensation for axis

⬆ Theoretical runtime motor, fully charged battery (DC-1201) and maximum power: 60 min

⬆ Theoretical runtime motor, fully charged battery (DC-1277) and maximum power: 180 min

TECHNICAL SPECIFICATIONS

Articlecode	Torque (Nm)	Speed (RPM)	Diameter (MM)	Motor Length (MM)	Cable Length (CM)	Power (W)	Current (A)	Tension (V)	Water Resistance	Price (€)
BJE24DD-0.6	0.8	34	24	210	30	10	0.83	12	IP20	€136,50

Controls - Power supply

Product	Article code	Description	Price
	DD-1802	Remote control 15 channels	€46,10
	DC-201	Transformer 12V JST US style	€19,90
	DC-202	Transformer 12V JST EU style	€19,90
	DC-203	Transformer 12V JST UK style	€19,90
	Z-43-025 / 050 / 100 / 200 / 500	Extension cable with JST plugs	From €6,50

Crown and Wheels - Motorbrackets

Product	Article code	Description	Price
	V4K5	Reducer 4k5	10 st. €3,85
	V6K5	Reducer 6k5	10 st. €3,85
	V6K6	Reducer 6k6	10 st. €3,85
	BP-24	Fixation bracket motor HD VB/PB headrail	€1,05
	BP-VA	Fixation bracket Vako 20.04/ Coulisse/ Heditex-Valencia	10 st. €4,30



Motor with Voltage-free switching

Specially made for Home Automation systems

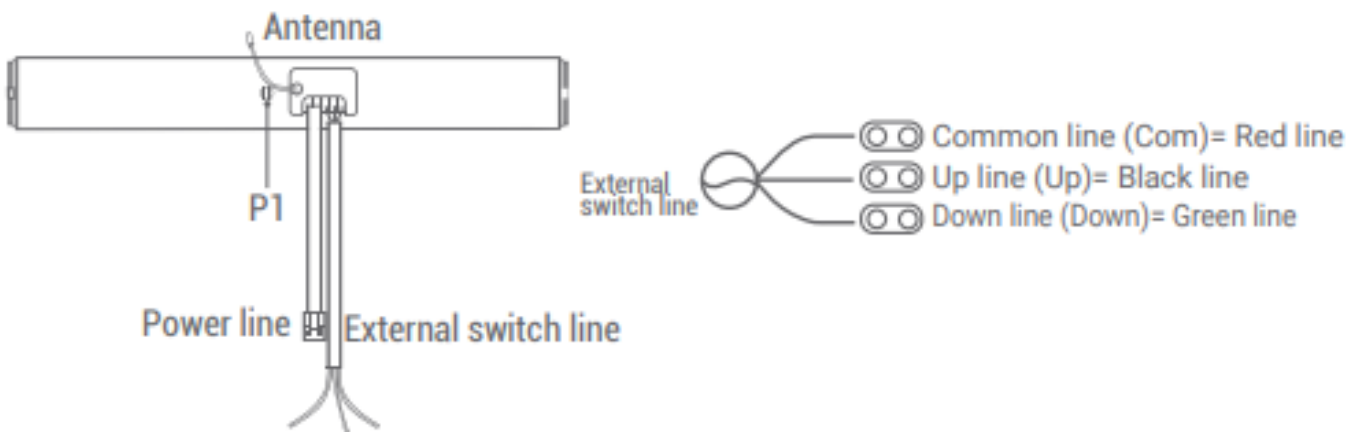

The BJE24DD motor is ideal for **projects** with indoor shading. Because the motor is equipped with an extra dry contact wire, it is very suitable for connection to home automation systems and building management systems. In addition, the motor is **easy to install** due to the bi-directional radio protocol.



FIBARO



LOXONE



SIEMENS

BJE24TD[®]

24mm 12V patent registered electronic DC radio motor TDBU with JST plug



- ⬆ Electronic limit setting

⬆ Built-in receiver

⬆ Dot-move function

⬆ Preference position / third limit 2x

⬆ Automatic power off switch
- ⬆ Backlash compensation for axis





⬆ Theoretical runtime motor, fully charged battery (DC-1201) and maximum power: 40 min

⬆ Theoretical runtime motor, fully charged battery (DC-1277) and maximum power: 120 min

TECHNICAL SPECIFICATIONS

Articlecode	Torque (Nm)	Speed (RPM)	Diameter (MM)	Motor Length (MM)	Cable Length (CM)	Power (W)	Current (A)	Tension (V)	Water Resistance	Price (€)
BJE24TD-0.6	2X 0.6	34	24	320	30	8	0.63	12	IP20	€221,50

Controls

Product	Article code	Description	Price
	DD-2762	Remote control TDBU 15 channels	€39,50
	DC-1201	12V Li-ion 950 MaH battery with 1x DIN 3.5 1x 1.35 JST	€27,50
	DC-1277	12V Li-ion 2600 mAh battery with 1x DIN 3.5 1x 1.35 JST	€52,50
	Z-43-025 / 050 / 100 / 200 / 500	Extension cable with JST plugs	From €6,50
	DC-212	Charger 12V DIN EU style	€19,90

Accessories

Product	Article code	Description	Price
	V4K5	Reducer 4k5	10 st. €3,85
	V6K5	Reducer 6k5	10 st. €3,85
	V6K6	Reducer 6k6	10 st. €3,85
	Z-75-4K5	Fixation for shaft 4k5	10 st. €4,65
	BP-24	Fixation bracket motor HD VB/PB headrail	€1,05



Top-Down-Bottom-Up motor[®]

Patent registered electronic motor for TDBU blinds



BREL HOME patented **top-down-bottom-up motor** is a specific motor for pleated and honeycomb blinds. With the top-down-bottom-up system you can easily control the bottom bar and the intermediate bar independently of each other. This motor is patent registered.

The BJE24TD top-down-bottom-up motor is a compact 12V radio motor where the top, bottom and intermediate positions can be adjust electronically. What is unique about this system is that it is electronically regulated that the bottom bar and the intermediate bar cannot pass each other. This makes a mechanical stop superfluous. A special remote control has been developed for this motor, so that the bottom bar and the intermediate bar can be operated separately.

Remote Control Type: **DD-1862**, **DD-2762** or **THB3115**



The Top-Down-Bottom-up motor can also be controlled with the BREL HOME app.

BJE24TR[®]

24mm 12V patent registered electronic DC radio motor Triangle



- ⬆ Electronic limit setting

⬆ Built-in receiver

⬆ Dot-move function

⬆ Preference position / third limit

⬆ Automatic power off switch
- ⬆ Backlash compensation for axis





⬆ Theoretical runtime motor, fully charged battery (DC-1201) and maximum power: 40 min

⬆ Theoretical runtime motor, fully charged battery (DC-1277) and maximum power: 120 min

TECHNICAL SPECIFICATIONS

Articlecode	Torque (Nm)	Speed (RPM)	Diameter (MM)	Motor Length (MM)	Cable Length (CM)	Power (W)	Current (A)	Tension (V)	Water Resistance	Price (€)
BJE24TR-0.6	2X 0.6	34	24	320	30	8	0.63	12	IP20	€229,90

Controls

Product	Article code	Description	Price
	THB3115	Remote control TDBU 15 channels	€51,10
	DC-1201	12V Li-ion 950 MaH battery with 1x DIN 1x JST	€27,50
	DC-1277	12V Li-ion 2600 mAh battery with 1x DIN 1x JST	€52,50
	Z-43-025 / 050 / 100 / 200 / 500	Extension cable with JST plugs	From €6,50
	DC-212	Charger 12V DIN EU style	€19,90

Accessories

Product	Article code	Description	Price
	V4K5	Reducer 4k5	10 st. €3,85
	V6K5	Reducer 6k5	10 st. €3,85
	V6K6	Reducer 6k6	10 st. €3,85
	Z-75	Fixation for shaft	€0,85
	BP-24	Fixation bracket motor HD VB/PB headrail	€1,05



Triangle motor[®]

Patent geregisteerde elektronische motor hoek plissé gordijnen



BREL HOME is continuously developing new motors. The BJE24TR was made in collaboration with **Benthin**. This motor has been specially developed for **angled windows**, so that they can be fitted with pleated blinds. The Triangle motor ensures that the intermediate bar of the pleated blind first goes down until it is horizontally. Then the bottom bar will drop to the end position. This prevents the angled pleated blind from getting stuck in the window.

Remote Control Type: **DD-1862**, **DD-2762** or **THB3115**

Winner of the Z&R Product of the Year Award 2022



BJE24Q

24mm 12V electronic radio motor double shaft with JST plug for horizontal pleated blinds







- ⬆️ **Electronic limit setting**
- ⬆️ **Backlash compensation for axis**
- ⬆️ **Built-in receiver**
- ⬆️ **Theoretical runtime motor, fully charged battery (DC-1201) and maximum power: 60 min**
- ⬆️ **Dot-move function**
- ⬆️ **Theoretical runtime motor, fully charged battery (DC-1277) and maximum power: 180 min**
- ⬆️ **Preference position / third limit**
- ⬆️ **Automatic power off switch**

TECHNICAL SPECIFICATIONS

Articlecode	Torque (Nm)	Speed (RPM)	Diameter (MM)	Motor Length (MM)	Cable Length (CM)	Power (W)	Current (A)	Tension (V)	Water Resistance	Price (€)
BJE24Q-0.8	0.8	34	24	210	30	10	0.83	12	IP20	€136,50

Controls

Product	Article code	Description	Price
	DD-1800	Remote control 1 channel	€41,10
	DC-1201	12V Li-ion 950 MaH battery with 1x DIN 1x JST	€27,50
	DC-1277	12V Li-ion 2600 MaH battery with 1x DIN 1x JST	€52,50
	Z-43-025 / 050 / 100 / 200 / 500	Extension cable with JST plugs	From €6,50
	DC-212	Charger 12V DIN EU style	€19,90

Accessories

Product	Article code	Description	Price
	V4K5	Reducer 4k5	10 st. €3,85
	V6K5	Reducer 6k5	10 st. €3,85
	V6K6	Reducer 6k6	10 st. €3,85
	Z-75	Fixation for shaft	€0,85
	BP-24	Fixation bracket Vako 20.04/ Coulisse/ Heditex-Valencia	€1,05

Endless cord motor

Electronic radio motor for horizontal pleated blinds with endless cord



BREL HOME is a specialist of pleated blinds motors. The **BJE24Q** is the sixth motor in the range. This motor has been specially developed by BREL HOME for pleated blinds with **endless cord**.

The new motor is for pleated blinds and is especially for patio roofs/verandas. The motor ensures that the pleated blinds can be controlled horizontally.

Remote Control Type: **DD-1802**, **DD-2702** or **THB3015**



BTE50

5V Tilt only electronic DC radio motor with Micro USB



- Electronic limit setting**
- Can be operated with wand**
- Built-in receiver**
- Charging with USB**
- Dot-move function**
- Outgoing axis square 6mm**
- Preference position / third limit**
- Outgoing axis hex 5mm**
- 5V DC motor**

TECHNICAL SPECIFICATIONS

Articlecode	Torque (Nm)	Speed (RPM)	Diameter (MM)	Motor Length (MM)	Cable Length (CM)	Power (W)	Current (A)	Tension (V)	Water Resistance	Price (€)
BTE50-W BTE50-B	0.6	10	31	91	X	5	0.54	8.4	IP20	€153,50

Included in set

Product	Article code	Description
BTE50-W Motorset White		
	DC-800E-K/W	Charging point white
	DC-800-E-P	Li-ion battery
BTE50-B Motorset Black		
	DC-800E-K/B	Charging point black
	DC-800-E-P	Li-ion battery

Accessories

Product	Article code	Description	Price
	Z-42-300M	USB cable 3m with magnet	€7,75
	Z-42-01	Magnetic plug Micro USB	€1,20
	DC-220	USB Charger EU style	€12,70
	DD-7002B	BREL HOME Hub WiFi RS485	€145,-
	DD-1800	Remote control 1 channel	€41,10



Notes

A series of horizontal dotted lines for writing notes, spanning the width of the page.

BLE15

15mm 8V electronic DC radio motor with Micro USB



-  **Electronic limit setting**
-  **Dot-move function**
-  **Built-in receiver**
-  **Preference position / third limit**
-  **8V DC with built-in Li-ion battery**
-  **Automatic power off switch**
-  **Low energy consumption**
-  **Motorhead 30mm (BLE15) or 40mm (BLET15)**

TECHNICAL SPECIFICATIONS

Articlecode	Torque (Nm)	Speed (RPM)	Diameter (MM)	Motor Length (MM)	Cable Length (CM)	Power (W)	Current (A)	Tension (V)	Water Resistance	Price (€)
BLE15-0.3 BLET15-0.3	0.3	30	15	370	X	5	0.60	8	IP20	€127,20

Controls

Product	Article code	Description	Price
	DD-250	Remote control 1 channel	€20,40
	DD-1805	Remote control with timer 5 channels	€63,60
	DD-2773	Wall remote 15 channels	€34,50
	DD-1554	BREL HOME Hub USB WiFi dongle bi-directional	€120,-
	HUB-03	BREL HOME Hub WiFi UTP/PoE	€165,-

Accessories

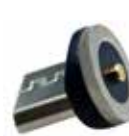
Product	Article code	Description	Price
	Z-42-300M	USB cable 3m with magnet	€7,75
	Z-42-01	Magnetic plug Micro USB	€1,20
	Z-42-02	Magnetic plug USB-C	€1,20
	DC-220	USB Charger EU style	€12,70
	DC-221	USB Charger UK style	€12,70

BLE20

20mm 8V electronic DC radio motor with USB-C



- ⬆️ **Electronic limit setting**

⬆️ **Built-in receiver**

⬆️ **8V DC with built-in Li-ion battery**

⬆️ **Low energy consumption**
- ⬆️ **Dot-move function**

⬆️ **Preference position / third limit**

⬆️ **Automatic power off switch**

⬆️ **Especially for 32mm tube**

TECHNICAL SPECIFICATIONS

Articlecode	Torque (Nm)	Speed (RPM)	Diameter (MM)	Motor Length (MM)	Cable Length (CM)	Power (W)	Current (A)	Tension (V)	Water Resistance	Price (€)
BLE20-0.5	0.5	28	20	450	X	8	2	8	IP20	€109,80

Crown and Wheels

Product	Article code	Description	Price
	ABB20-15	Adaption Benthin tube 20	€1,90
	ACC25-15	Adaption Coulisse tube 25	€1,90
	ALO32-15	Adaption Louvolite tube 32	€1,90
	ACC28-22	Adaption Coulisse tube 28	€2,40
	AHD32-22	Adaption Hunter Douglas tube 32	€1,90

Motorbrackets

Product	Article code	Description	Price
	AL032-22	Adaption Louvolite tube 32	€1,90
	ABB38-22	Motorbracket HD tube 22	€2,40
	BRCCA-22	Motorbracket Coulisse tube	€2,40
	BRS-25	Motorbracket HD tube	€1,90
	BRL-32	Motorbracket Louvolite tube	€2,40

BLE25

25mm 5V electronic DC radio motor with USB-C



- ⤴ Electronic limit setting

⤴ Built-in receiver

⤴ 5V DC with built-in Li-ion battery

⤴ Low energy consumption
- ⤴ Dot-move function

⤴ Preference position / third limit

⤴ Automatic power off switch





TECHNICAL SPECIFICATIONS

Articlecode	Torque (Nm)	Speed (RPM)	Diameter (MM)	Motor Length (MM)	Cable Length (CM)	Power (W)	Current (A)	Tension (V)	Water Resistance	Price (€)
BLE25-1.1	1.1	28	25	480	X	8	1.2	5	IP20	€118,50

Controls

Product	Article code	Description	Price
	THB3001	Remote control 1 channel	€45,55
	DD-2705	Remote control with timer 5 channels	€53,50
	DD-2712	Remote control Tilt & Lift 15 channels	€39,50
	DD-7002B	BREL HOME Hub WiFi RS485	€145,-
	DD-1557	Repeater	€26,50

Accessories

Product	Article code	Description	Price
	DD-1149	Dry contact remote	€31,30
	Z-42-300M	USB kabel 3m with magnet	€7,75
	Z-42-02	Magnetic plug USB-C	€1,20
	DC-220	USB Charger EU style	€12,70
	DC-221	USB Charger UK style	€12,70

BPE25

25mm 230V electronic radio motor



- ⤴ Electronic limit setting**
- ⤴ Dot-move function**
- ⤴ Built-in receiver**
- ⤴ Preference position / third limit**
- ⤴ 230V AC**
- ⤴ Automatic power off switch**
- ⤴ Extra powerfull motor**
- ⤴ Voltage-free switching (BPE25DD)**











TECHNICAL SPECIFICATIONS

Articlecode	Torque (Nm)	Speed (RPM)	Diameter (MM)	Motor Length (MM)	Cable Length (CM)	Power (W)	Current (A)	Tension (V)	Water Resistance	Price (€)
BPE25-1.5	1.5	32	25	440	500	13	0.15	110-240	IP20	€111,50
BPE25DD-1.5	1.5	32	25	440	500	13	0.15	110-240	IP20	€119,90

Crown and Wheels

&

Motorbrackets

Product	Article code	Description	Price	Product	Article code	Description	Price
	ACC28-25	Adaption Coulisse tube 28	€2,40		ALO40-25	Adaption Louvolite tube 40	€2,40
	ACC30-25	Adaption Coulisse tube 30	€2,40		ALO45-25	Adaption Louvolite tube 45	€2,40
	AHD32-25	Adaption Hunter Douglas tube 32	€2,40		BRS-25	Motorbracket HD tube	€1,90
	AHD34-25	Adaption Hunter Douglas tube 34	€2,40		BRL-32	Motorbracket Louvolite tube	€2,40
	ABB38-25	Adaption Benthin tube 38	€2,40		BRCCA-25	Motorbracket Coulisse tube	€2,40

BLEQ28

28mm 12V silent electronic DC radio motor with USB-C



- ⬆️ **Electronic limit setting**
- ⬆️ **Dot-move function**
- ⬆️ **Built-in receiver**
- ⬆️ **Preference position / third limit**
- ⬆️ **12V DC with built-in Li-ion battery**
- ⬆️ **Automatic power off switch**
- ⬆️ **Low energy consumption**
- ⬆️ **Extra silent motor (54 db)**





TECHNICAL SPECIFICATIONS

Articlecode	Torque (Nm)	Speed (RPM)	Diameter (MM)	Motor Length (MM)	Cable Length (CM)	Power (W)	Current (A)	Tension (V)	Water Resistance	Price (€)
BLEQ28-2	2	28	28	645	X	13	1.13	12	IP20	€194,50

Controls

Product	Article code	Description	Price
	DD-250	Remote control 1 channel	€20,40
	DD-2712	Remote control Tilt & Lift 15 channels	€39,50
	DD-1873	Wall remote 15 channels	€45,10
	DD-1554	BREL HOME Hub USB WiFi dongle bi-directional	€120,-
	DD-1149	Dry contact remote	€31,30

Accessories

Product	Article code	Description	Price
	DD-1557	Repeater	€26,50
	Z-42-300M	USB cable 3m with magnet	€7,75
	Z-42-02	Magnetic plug USB-C	€1,20
	DC-220	USB Charger EU style	€12,70
	DC-221	USB Charger UK style	€12,70

BPEQ28

28mm 230V silent electronic radio motor



- ⤴ Electronic limit setting
- ⤴ Built-in receiver
- ⤴ 230V AC
- ⤴ Extra powerfull motor

- ⤴ Dot-move function
- ⤴ Preference position / third limit
- ⤴ Automatic power off switch
- ⤴ Extra silent motor (54 db)



TECHNICAL SPECIFICATIONS

Articlecode	Torque (Nm)	Speed (RPM)	Diameter (MM)	Motor Length (MM)	Cable Length (CM)	Power (W)	Current (A)	Tension (V)	Water Resistance	Price (€)
BPEQ28-2	2	28	28	645	5	18	1.0	110-240	IP20	€179,20

Crown and Wheels

&

Motorbrackets

Product	Article code	Description	Price	Product	Article code	Description	Price
	AHD38-28	Adaption Hunter Douglas tube 38	€2,40		ACC65-28	Adaption Coulisse tube 65	€2,40
	AHD40-28	Adaption Hunter Douglas tube 40	€2,40		ACC80-28	Adaption Coulisse tube 80	€4,20
	ABB43-28	Adaption Benthin tube 43	€2,40		BRS-28	Motorbracket HD tube	€1,90
	ALO45-28	Adaption Louvolite tube 45	€2,40		BRL-32	Motorbracket Louvolite tube	€2,40
	ABB52-28	Adaption Benthin tube 52	€3,40		BRCCA-28	Motorbracket Coulisse tube	€2,40



BLEQ35

35mm 12V electronic DC radio motor with DIN plug or USB-C



- ⤴ Electronic limit setting**
- ⤴ Dot-move function**
- ⤴ Built-in receiver**
- ⤴ Preference position / third limit**
- ⤴ 12V DC with built-in Li-ion battery**
- ⤴ Automatic power off switch**
- ⤴ Extra powerfull motor**
- ⤴ Extra silent motor (54 db)**

TECHNICAL SPECIFICATIONS

Articlecode	Torque (Nm)	Speed (RPM)	Diameter (MM)	Motor Length (MM)	Cable Length (CM)	Power (W)	Current (A)	Tension (V)	Water Resistance	Price (€)
BLEQ35-6	6	24	35	694	15	38	3.23	12	IP44	€230,50
BLEQ35-6 USB-C	6	24	35	694	15	38	3.23	12	IP44	€230,50

Controls

Product	Article code	Description	Price
	DD-1802	Remote control 15 channels	€46,10
	DD-2705	Remote control with timer 5 channels	€53,50
	DD-2773	Wall remote 15 channels	€34,50
	DD-1554	BREL HOME Hub USB WiFi dongle bi-directional	€120,-
	DD-118	Sun- and wind meter wireless	€81,50

Accessories

Product	Article code	Description	Price
	Z-46-001	Three-way plug DIN for Solar	€5,70
	Z-46-025 / 050 / 100 / 200 / 500	Extension wire with DIN for Solar	From €8,50
	DC-212	Charger 12V DIN EU style	€19,90
	DC-213	Charger 12V DIN UK style	€19,90
	NC-1290	Solar panel with waterproof DIN black housing 554x60x10mm	€53,95

BLE35

35mm 12V electronic DC radio motor with DIN plug or USB-C



- ⤴ Electronic limit setting**
- ⤴ Dot-move function**
- ⤴ Built-in receiver**
- ⤴ Theoretical runtime motor, fully charged battery and maximum power: 55 min**
- ⤴ 12V DC with built-in Li-ion battery**
- ⤴ Especially for Solar**
- ⤴ Low energy consumption**



TECHNICAL SPECIFICATIONS

Articlecode	Torque (Nm)	Speed (RPM)	Diameter (MM)	Motor Length (MM)	Cable Length (CM)	Power (W)	Current (A)	Tension (V)	Water Resistance	Price (€)
BLE35-13	13	10	35	670	15	38	3.23	12	IP44	€228,50
BLE35-13 USB-C	13	10	35	670	15	38	3.23	12	IP44	€228,50

Crown and Wheels

&

Motorbrackets

Product	Article code	Description	Price
	A8K40-35	Adaption octagon 40 tube 35 mm motor	€1,80
	A40-35	Adaption 40 tube 35 mm motor	€1,60
	A41-35	Adaption octagon 41 tube 35 mm motor	€2,65
	A50-35	Adaption 50 tube 35 mm motor	€2,65
	AZ63C	Bung tube 63 for zipscreen	€3,15

Product	Article code	Description	Price
	A8K60/63-45	Adaption octagon 60/63 tube 45 mm motor	€2,65
	V35-45	Adaption from 35 mm to 45 mm motor	€0,85
	KR-35-E	Motorbracket 35mm electronic motor	€2,65
	BR-45	Motorbracket for shutter max. 50Nm	€1,90
	BZ-45	Motorbracket for awnings max. 50Nm	€2,10

BCE35

35 mm 12V electronic DC radio motor with external battery and DIN plug



-  **Electronic limit setting**
-  **Theoretical runtime motor, fully charged battery (DC-1293) and maximum power: 94 min**
-  **Built-in receiver**
-  **Especially for Solar**
-  **Low energy consumption**
-  **Extra short**
-  **Dot-move function**

TECHNICAL SPECIFICATIONS

Articlecode	Torque (Nm)	Speed (RPM)	Diameter (MM)	Motor Length (MM)	Cable Length (CM)	Power (W)	Current (A)	Tension (V)	Water Resistance	Price (€)
BCE35-06	6	24	35	503	15	35	3.00	12	IP20	€143,25

Controls - Power supply

Product	Article code	Description	Price
	THB3015	Remote control 15 channels	€51,10
	DD-1802	Remote control 15 channels	€46,10
	HUB-03	BREL HOME Hub WiFi UTP/PoE	€165,-
	DC-1293	Battery 12V 5100 mAh for BCE motors	€116,40
	NC-1290	Solar panel with waterproof DIN black housing 554x60x10mm	€53,95

Crown and Wheels - Motorbrackets

Product	Article code	Description	Price
	A8K40-35	Adaption octagon 40 tube 35 mm motor	€1,80
	A8K60/63-45	Adaption octagon 60/63 tube 45 mm motor	€2,65
	V35-45	Adaption from 35 mm to 45 mm motor	€0,85
	BR-45	Motorbracket for shutter max. 50Nm	€1,90
	BZ-45	Motorbracket for awnings max. 50Nm	€2,10



Notes

A series of horizontal dotted lines for writing notes, spanning the width of the page.

BEQ35

35mm 230V silent electronic radio motor



- ⤴ Electronic limit setting**
- ⤴ Dot-move function**
- ⤴ Built-in receiver**
- ⤴ Silent motor (54 db)**
- ⤴ 230V AC**
- ⤴ Voltage-free switching (BEQ35DD)**









TECHNICAL SPECIFICATIONS

Articlecode	Torque (Nm)	Speed (RPM)	Diameter (MM)	Motor Length (MM)	Cable Length (CM)	Power (W)	Current (A)	Tension (V)	Water Resistance	Price (€)
BEQ35-6	6	28	35	590	500	133	0.57	230	IP44	€123,00
BEQ35-10	10	17	35	590	500	155	0.67	230	IP44	€129,10
BEQ35DD-10	10	17	35	590	500	155	0.67	230	IP44	€139,10

Controls

&

Accessories

Product	Article code	Description	Price	Product	Article code	Description	Price
	DD-251	Remote control 5 channels	€23,50		DD-118	Sun- and wind meter wireless	€81,50
	DD-1800	Remote control 1 channel	€41,10		DD-1149	Dry contact remote	€31,30
	DD-2712	Remote control Tilt & Lift 15 channels	€39,50		DD-117	Dry contact receiver	€47,10
	DD-7002B	BREL HOME Hub WiFi RS485	€145,-		Z-33	Cable 3-core 0.75mm ² per 100m	€112,50
	HUB-03	BREL HOME Hub WiFi UTP/PoE	€165,-		Z-40	250 cm cable and plug	€4,90

BR35

35mm 230V mechanic radio motor



- ⤴ Mechanic limit setting
- ⤴ 230V AC

- ⤴ Built-in receiver
- ⤴ Dot-move and light adjust function

TECHNICAL SPECIFICATIONS

Articlecode	Torque (Nm)	Speed (RPM)	Diameter (MM)	Motor Length (MM)	Cable Length (CM)	Power (W)	Current (A)	Tension (V)	Water Resistance	Price (€)
BR35-10	10	17	35	596	500	121	0.53	230	IP44	€100,00
BR35-13	13	14	35	596	500	121	0.53	230	IP44	€106,70

Crown and Wheels

&

Motorbrackets

Product	Article code	Description	Price	Product	Article code	Description	Price
	A8K40-35	Adaption octagon 40 tube 35 mm motor	€1,80		A8K60/63-45	Adaption octagon 60/63 tube 45 mm motor	€2,65
	A40-35	Adaption 40 tube 35 mm motor	€1,60		V35-45	Adaption from 35 mm to 45 mm motor	€0,85
	A41-35	Adaption octagon 41 tube 35 mm motor	€2,65		KR-35-S	Motorbracket 35mm standard motor	€2,65
	A50-35	Adaption 50 tube 35 mm motor	€2,65		BR-45	Motorbracket for shutter max. 50Nm	€1,90
	AZ63C	Bung tube 63 for zipscreen	€3,15		KR-45	Motorbracket 45 mm crown	€4,50

BEK45

45mm 230V extra short electronic radio motor



- ⤴ Electronic limit setting
- ⤴ Built-in receiver
- ⤴ 230V AC

- ⤴ Dot-move function
- ⤴ Preference position / third limit
- ⤴ Ultra short motor





TECHNICAL SPECIFICATIONS

Articlecode	Torque (Nm)	Speed (RPM)	Diameter (MM)	Motor Length (MM)	Cable Length (CM)	Power (W)	Current (A)	Tension (V)	Water Resistance	Price (€)
BEK45-10	10	15	45	395	300	113	0.48	230	IP44	€127,50

Controls

Product	Article code	Description	Price
	DD-251	Remote control 5 channels	€23,50
	DD-2700	Remote control 1 channel	€32,50
	DD-1805	Remote control with timer 5 channels	€63,60
	DD-2770	Wall remote 1 channel	€29,20
	DD-7002B	BREL HOME Hub WiFi RS485	€145,-

Accessories

Product	Article code	Description	Price
	DD-116	Sun- and wind meter 230V	€68,40
	DD-1149	Dry contact remote	€31,30
	DD-117	Dry contact receiver	€47,10
	Z-33	Cable 3-core 0.75mm ² per 100m	€112,50
	Z-40	250 cm cable and plug	€4,90

BR45

45mm 230V mechanic radio motor



- ⤴ Mechanic limit setting
- ⤴ 230V AC

- ⤴ Built-in receiver
- ⤴ Dot-move and light adjust function









TECHNICAL SPECIFICATIONS

Articlecode	Torque (Nm)	Speed (RPM)	Diameter (MM)	Motor Length (MM)	Cable Length (CM)	Power (W)	Current (A)	Tension (V)	Water Resistance	Price (€)
BR45-20	20	15	45	612	500	145	0.64	230	IP44	€102,50
BR45-40	40	15	45	643	500	198	0.86	230	IP44	€108,50

Crown and Wheels

&

Motorbrackets

Product	Article code	Description	Price	Product	Article code	Description	Price
	A8K50-45	Adaption octagon 50 tube 45 mm motor	€2,65		A8K70-45	Adaption octagon 70 tube 45 mm motor	€4,45
	A8K60/63-45	Adaption octagon 60/63 tube 45 mm motor	€2,65		A78-45	Adaption 78 tube 45 mm motor	€4,25
	A63-45	Adaption 63 tube 45 mm motor	€4,45		KR-45	Motorbracket 45 mm crown	€4,50
	AZ63-45	Adaption for zipscreen 63 tube 45 mm	€5,00		BR-45	Motorbracket for shutter max. 50Nm	€1,90
	A70-45	Adaption 70 tube 45 mm motor	€4,45		BZ-45	Motorbracket for awnings max. 50Nm	€2,10



BRE45

45mm 230V electronic radio motor for roller shutters with WiFi



- ⤴ Electronic limit setting
- ⤴ Built-in receiver with WiFi

- ⤴ Dot-move function
- ⤴ Obstacle stop function





TECHNICAL SPECIFICATIONS

Articlecode	Torque (Nm)	Speed (RPM)	Diameter (MM)	Motor Length (MM)	Cable Length (CM)	Power (W)	Current (A)	Tension (V)	Water Resistance	Price (€)
BRE45-10	10	15	45	610	500	112	0.49	230	IP44	€122,10
BRE45-20 WiFi	20	15	45	610	500	161	0.69	230	IP44	€129,40
BRE45-40 WiFi	40	15	45	660	500	188	0.86	230	IP44	€143,50

Controls

Product	Article code	Description	Price
	DD-115	Mini Remote control	€21,50
	DD-2700	Remote control 1 channel	€32,50
	DD-1873	Wall remote 15 channels	€45,10
	DD-1554	BREL HOME Hub USB WiFi dongle bi-directional	€120,-
	DD-118	Sun- and wind meter wireless	€81,50

Accessories

Product	Article code	Description	Price
	DD-510	Shock sensor	€55,80
	DD-1149	Dry contact remote	€31,30
	DD-117	Dry contact receiver	€47,10
	Z-33	Cable 3-core 0.75mm2 per 100m	€112,50
	Z-40	250 cm cable and plug	€4,90

BZE45

45mm 230V electronic radio motor for awnings and screens with WiFi



-  **Electronic and automatic limit setting**
-  **Preference position / third limit**
-  **Built-in receiver with Wifi at 40 Nm**
-  **Obstacle stop function**
-  **Dot-move function**
-  **Automatic fabric tension**

TECHNICAL SPECIFICATIONS

Articlecode	Torque (Nm)	Speed (RPM)	Diameter (MM)	Motor Length (MM)	Cable Length (CM)	Power (W)	Current (A)	Tension (V)	Water Resistance	Price (€)
BZE45-20 WiFi	20	15	45	610	500	161	0.69	230	IP44	€129,40
BZE45-40 WiFi	40	15	45	660	500	188	0.86	230	IP44	€143,50

Crown and Wheels

&

Motorbrackets

Product	Article code	Description	Price	Product	Article code	Description	Price
	A8K50-45	Adaption octagon 50 tube 45 mm motor	€2,65		A8K70-45	Adaption octagon 70 tube 45 mm motor	€4,45
	A8K60/63-45	Adaption octagon 60/63 tube 45 mm motor	€2,65		A78-45	Adaption 78 tube 45 mm motor	€4,25
	A63-45	Adaption 63 tube 45 mm motor	€4,45		KR-45	Motorbracket 45 mm crown	€4,50
	AZ63-45	Adaption for zipscreen 63 tube 45 mm	€5,00		BR-45	Motorbracket for shutter max. 50Nm	€1,90
	A70-45	Adaption 70 tube 45 mm motor	€4,45		BZ-45	Motorbracket for awnings max. 50Nm	€2,10

BLE45

45mm 12V electronic DC radio motor with DIN plug



- ⬆️ **Electronic limit setting**
- ⬆️ **Dot-move function**
- ⬆️ **Built-in receiver**
- ⬆️ **Preference position / third limit**
- ⬆️ **12V DC with built-in Li-ion battery**
- ⬆️ **Automatic power off switch**
- ⬆️ **Low energy consumption**
- ⬆️ **Especially for Solar**

TECHNICAL SPECIFICATIONS

Articlecode	Torque (Nm)	Speed (RPM)	Diameter (MM)	Motor Length (MM)	Cable Length (CM)	Power (W)	Current (A)	Tension (V)	Water Resistance	Price (€)
BLE45-20	20	10	45	742	15	50	4.10	12	IP44	€243,60
BLE45-50	50	5	45	664	15	50	4.10	12	IP44	€254,50

Controls

Product	Article code	Description	Price
	DD-1802	Remote control 15 channels	€46,10
	DD-1554	BREL HOME Hub USB WiFi dongle bi-directional	€120,-
	DD-118	Sun- and wind meter wireless	€81,50
	Z-46-001	Three-way plug DIN for Solar	€5,70
	Z-46-025 / 050 / 100 / 200 / 500	Extension wire with DIN for Solar	From €8,50

Accessories

Product	Article code	Description	Price
	NC-1290	Solar panel with waterproof DIN black housing 554x60x10mm	€53,95
	NC-1291	Solar panel with waterproof DIN without housing 530x56x3mm	€53,95
	NC-1297	Solar panel with waterproof DIN glass, without housing 750x40x13mm	€75,95
	A8K60/63-45	Adaption octagon 60/63 tube 45 mm motor	€2,65
	KR-45	Motorbracket 45 mm crown	€4,50



BREL WiFi

Bi-directional motors with integrated Wifi function



In 2022, BREL HOME introduced the first 230 volt motors with a built-in receiver with WiFi. The range now includes 20Nm and 40Nm WiFi motors of the type **BRE45** and **BZE45**. The BRE45 motors have been specially developed for roller shutters and the BZE45 for awnings and screens.

The beauty of a BREL HOME Wifi motor is that it no longer needs a HUB, it is directly registered to the wifi network. Only the BREL HOME App is required.

The new Wifi motor has a **number of functionalities**. The end limits (upper and lower position) are (automatically) electronically adjusted, a preferred position can be set and the motor has obstacle stop detection if desired. In the BREL HOME App, any position and situation can be captured with the scenarios.

Because it is a **bi-directional motor**, the app knows exactly where the product is located. A practical side effect is that the motor also remains a radio motor, and can therefore also be operated with a normal BREL HOME remote control.

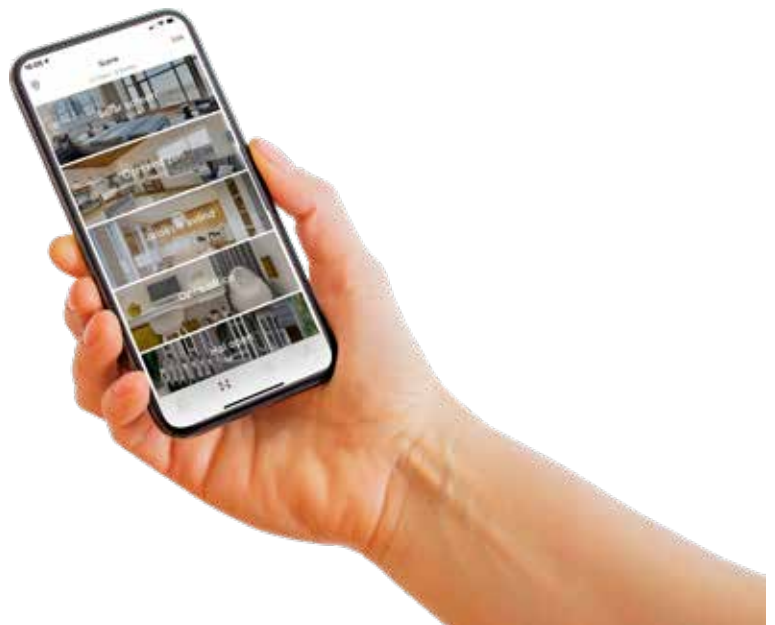



Solar motors

BREL Solar	40
BLE35-13	41
BLE45-20	41
BLE45-50	42
BCE35-06	42
Solar panels	43
Accessories	44





BREL Solar

Bi-directional motors with solar panel



The Solar motors from BREL HOME are rechargeable Li-ion battery motors with a solar panel, especially for shutters and screens. Our battery motors are **100% wireless** and easy to install. The battery is charged by solar energy. The motors can also be controlled smartly with the BREL HOME app and a HUB. The motors can ofcourse be operated with a remote control.

Motor type: **BLE35-13, BLE45-20, BLE45-50 or BCE35-06**

Remote control tyoe: **DD-250 series, DD-2700 series, DD-1800 series or THB series**



BREL HOME has made its own BREL Solar App especially for our Solar motors. With the help of this app you can easily and quickly determine the perfect location for the solar panel.

Download the BREL Solar App here:



BLE35-13

35 mm 12V electronic DC radio motor with DIN plug



- ⤴ Electronic limit setting**
- ⤴ Dot-move function**
- ⤴ Built-in receiver**
- ⤴ Theoretical runtime motor, fully charged battery and maximum power: 55 min**
- ⤴ 12V DC with built-in Li-ion battery**

TECHNICAL SPECIFICATIONS

Articlecode	Torque (Nm)	Speed (RPM)	Diameter (MM)	Motor Length (MM)	Cable Length (CM)	Power (W)	Current (A)	Tension (V)	Water Resistance	Price (€)
BLE35-13	13	10	35	670	15	38	3.23	12	IP44	€228,50

BLE45-20

45 mm 12V electronic DC radio motor with DIN plug



- ⤴ Electronic limit setting**
- ⤴ Dot-move function**
- ⤴ Built-in receiver**
- ⤴ Theoretical runtime motor, fully charged battery and maximum power: 49 min**
- ⤴ 12V DC with built-in Li-ion battery**

TECHNICAL SPECIFICATIONS

Articlecode	Torque (Nm)	Speed (RPM)	Diameter (MM)	Motor Length (MM)	Cable Length (CM)	Power (W)	Current (A)	Tension (V)	Water Resistance	Price (€)
BLE45-20	20	10	45	664	15	50	4.10	12	IP44	€243,60



BLE45-50

45 mm 12V electronic DC radio motor with DIN plug



- ⤴ Electronic limit setting
 - ⤴ Built-in receiver
 - ⤴ 12V DC with built-in Li-ion battery
- ⤴ Dot-move function
 - ⤴ Theoretical runtime motor, fully charged battery and maximum power: 49 min

TECHNICAL SPECIFICATIONS

Articlecode	Torque (Nm)	Speed (RPM)	Diameter (MM)	Motor Length (MM)	Cable Length (CM)	Power (W)	Current (A)	Tension (V)	Water Resistance	Price (€)
BLE45-50	50	5	45	664	15	50	4.10	12	IP44	€254,50

BCE35-06

35 mm 12V electronic DC radio motor with external battery and DIN plug



- ⤴ Electronic limit setting
 - ⤴ Built-in receiver
 - ⤴ 12V DC with built-in Li-ion battery
 - ⤴ Low energy consumption
- ⤴ Dot-move function
 - ⤴ Theoretical runtime motor, fully charged battery (DC-1293) and maximum power: 94 min
 - ⤴ Especially for short roller shutters and screens

TECHNICAL SPECIFICATIONS

Articlecode	Torque (Nm)	Speed (RPM)	Diameter (MM)	Motor Length (MM)	Cable Length (CM)	Power (W)	Current (A)	Tension (V)	Water Resistance	Price (€)
BCE35-06	6	24	35	503	15	35	3.00	12	IP20	€143,25

Solar panels

Accessories

Product	Article code	Description	Price
	NC-1290	Solar panel with waterproof DIN plug, black housing 554x60x10mm	€53,95
	NC-1291	Solar panel with waterproof DIN plug without housing 530x56x3mm	€53,95
	NC-1295	Solar panel with waterproof DIN plug, black housing 1085x60x10mm	€114,50
	NC-1297	Solar panel with waterproof DIN plug, black housing 750x40x13mm	€75,95

Accessories

Product	Article code	Description	Price	Product	Article code	Description	Price
	DD-1800	Remote control 1 channel	€41,10		THB3001	Remote control 1 channel	€45,55
	DD-1802	Remote control 15 channels	€46,10		THB3015	Remote control 15 channels	€51,10
	DD-1870	Wall remote 1 channel	€39,60		DD-118	Sun- and wind meter wireless	€81,50
	DD-1873	Wall remote 15 channels	€45,10		DD-7002B	BREL HOME Hub WiFi RS485	€145,-
	DD-2700	Remote control 1 channel	€32,50		DD-1554	BREL HOME Hub USB WiFi dongle bi-directional	€120,-
	DD-2702	Remote control 15 channels	€37,90		Z-46-001	Three-way plug DIN for Solar	€5,70
	DD-2770	Wall remote 1 channel	€29,20		Z-46-005	DIN charging point with fixing nut extension cable	€8,50
	DD-2773	Wall remote 15 channels	€34,50		Z-46-025 / 050 / 100 / 200 / 500	Extension wire with DIN for Solar	From €8,50
	DD-250	Remote control 1 channel	€20,40		DC-212	Charger 12V DIN EU style	€19,90
	DD-251	Remote control 5 channels	€23,50		DC-1293	Battery BCE35 motor	€116,40

Other

Accessories

Product	Article Code	Description	Price
	VAS35-HE-95	Cover plate for cable 35mm Solar motor Heroal screen 95	€2,40
	VAS35-HE-105	Cover plate for cable 35mm Solar motor Heroal screen 105	€2,40
	VAS45- AVZ-95	Cover plate for cable 45mm Solar motor AVZ screen 95	€3,10
	VAS45-HE-95	Cover plate for cable 45mm Solar motor Heroal screen 95	€3,10
	VAS45-HE-105	Cover plate for cable 45mm Solar motor Heroal screen 105	€3,10
	VAS45-HE-125	Cover plate for cable 45mm Solar motor Heroal screen 125	€3,50



Pleated blinds motors

Special motors for pleated blinds	48
BJE24S	49
BJE24D	49
BJE24DD	50
BJE24TR	50
BJE24TD	51
BJE24Q	51
Accessories	52





Special motors for pleated blinds

Six types of motors

BREL HOME has six different motors for pleated curtains. For the standard pleated blinds, BREL HOME has the BJE24S side motor and the BJE24D middle motor in its range and for standard pleated blinds for projects there is the BJE24DD motor.

Top down bottom up motor

The BJE24TD top-down-bottom-up motor is a compact 12V radio motor where the top, bottom and intermediate positions can be electronically adjusted. What is unique about this system is that it is electronically controlled that the bottom bar and the intermediate bar cannot pass each other. This makes a mechanical stopper superfluous. A special remote control has also been developed for this motor so that the bottom slat and the intermediate slat can be controlled separately from each other.

Triangle motor

Sloping windows require a unique solution. These windows can be equipped with **slanted pleated blinds**. The new motor is the **BJE24TR** and ensures that the intermediate slat of the pleated blind first goes down until it is horizontal. Then the bottom slat drops to the end position. This prevents the slanted pleated blind from getting stuck in the window. The triangle motor has been declared the winner of the Z&R Product of the Year Award 2022.

Endless cord motor

The new motor for pleated blinds has been specially designed for **patio roofs/verandas**. The motor ensures that the pleated blinds can be controlled horizontally. This new motor is the **BJE24Q**.

Endless cord motor

De nieuwe motor voor plissé gordijnen is speciaal ontworpen voor **terrasoverkappingen/veranda's**. De motor zorgt ervoor dat de plissé gordijnen horizontaal bestuurd kunnen worden. Deze nieuwe motor is de **BJE24Q**.

BJE24S

24mm 12V electronic radio motor single shaft with JST plug



- ⤴ Electronic limit setting**
- ⤴ Backlash compensation for axis**
- ⤴ Built-in receiver**
- ⤴ Theoretical runtime motor, fully charged battery (DC-1201) and maximum power: 95 min**
- ⤴ Dot-move function**
- ⤴ Theoretical runtime motor, fully charged battery (DC-1277) and maximum power: 280 min**
- ⤴ Preference position / third limit**
-
- ⤴ Automatic power off switch**

TECHNICAL SPECIFICATIONS

Articlecode	Torque (Nm)	Speed (RPM)	Diameter (MM)	Motor Length (MM)	Cable Length (CM)	Power (W)	Current (A)	Tension (V)	Water Resistance	Price (€)
BJE24S-0.6	0.6	34	24	129	30	6.4	0.56	12	IP20	€109,50

BJE24D

24mm 12V electronic radio motor double shaft with JST plug



- ⤴ Electronic limit setting**
- ⤴ Backlash compensation for axis**
- ⤴ Built-in receiver**
- ⤴ Theoretical runtime motor, fully charged battery (DC-1201) and maximum power: 60 min**
- ⤴ Dot-move function**
- ⤴ Theoretical runtime motor, fully charged battery (DC-1277) and maximum power: 180 min**
- ⤴ Preference position / third limit**
-
- ⤴ Automatic power off switch**

TECHNICAL SPECIFICATIONS

Articlecode	Torque (Nm)	Speed (RPM)	Diameter (MM)	Motor Length (MM)	Cable Length (CM)	Power (W)	Current (A)	Tension (V)	Water Resistance	Price (€)
BJE24D-0.8	0.8	34	24	210	30	10	0.83	12	IP20	€119,50



BJE24DD

24mm 12V electronic radio motor double shaft and double wired with JST plug and voltage-free switching



- ⤴ Electronic limit setting

⤴ Built-in receiver

⤴ Dot-move function

⤴ Preference position / third limit

⤴ Automatic power off switch
- ⤴ Backlash compensation for axis

⤴ Theoretical runtime motor, fully charged battery (DC-1201) and maximum power: 60 min

⤴ Theoretical runtime motor, fully charged battery (DC-1277) and maximum power: 180 min

TECHNICAL SPECIFICATIONS

Articlecode	Torque (Nm)	Speed (RPM)	Diameter (MM)	Motor Length (MM)	Cable Length (CM)	Power (W)	Current (A)	Tension (V)	Water Resistance	Price (€)
BJE24DD-0.6	0.8	34	24	210	30	10	0.83	12	IP20	€136,50

BJE24TD

24mm 12V patent registered electronic DC radio motor TDBU with JST plug



- ⤴ Electronic limit setting

⤴ Built-in receiver

⤴ Dot-move function

⤴ Preference position / third limit 2x

⤴ Automatic power off switch
- ⤴ Backlash compensation for axis

⤴ Theoretical runtime motor, fully charged battery (DC-1201) and maximum power: 40 min

⤴ Theoretical runtime motor, fully charged battery (DC-1277) and maximum power: 120 min

TECHNICAL SPECIFICATIONS

Articlecode	Torque (Nm)	Speed (RPM)	Diameter (MM)	Motor Length (MM)	Cable Length (CM)	Power (W)	Current (A)	Tension (V)	Water Resistance	Price (€)
BJE24TD-0.6	2X 0.6	34	24	320	30	8	0.63	12	IP20	€221,50

BJE24TR

24mm 12V patent registered electronic DC radio motor Triangle



- ⤴ Electronic limit setting
- ⤴ Built-in receiver
- ⤴ Dot-move function
- ⤴ Preference position / third limit
- ⤴ Automatic power off switch
- ⤴ Backlash compensation for axis
- ⤴ Theoretical runtime motor, fully charged battery (DC-1201) and maximum power: 40 min
- ⤴ Theoretical runtime motor, fully charged battery (DC-1277) and maximum power: 120 min

TECHNICAL SPECIFICATIONS

Articlecode	Torque (Nm)	Speed (RPM)	Diameter (MM)	Motor Length (MM)	Cable Length (CM)	Power (W)	Current (A)	Tension (V)	Water Resistance	Price (€)
BJE24TR-0.6	2X 0.6	34	24	320	30	8	0.63	12	IP20	€229,90

BJE24Q

24mm 12V electronic radio motor double shaft with JST plug for horizontal pleated blinds



- ⤴ Electronic limit setting
- ⤴ Built-in receiver
- ⤴ Dot-move function
- ⤴ Preference position / third limit
- ⤴ Automatic power off switch
- ⤴ Backlash compensation for axis
- ⤴ Theoretical runtime motor, fully charged battery (DC-1201) and maximum power: 60 min
- ⤴ Theoretical runtime motor, fully charged battery (DC-1277) and maximum power: 180 min

TECHNICAL SPECIFICATIONS

Articlecode	Torque (Nm)	Speed (RPM)	Diameter (MM)	Motor Length (MM)	Cable Length (CM)	Power (W)	Current (A)	Tension (V)	Water Resistance	Price (€)
BJE24Q-0.8	0.8	34	24	210	30	10	0.83	12	IP20	€136,50

Accessories

Product	Article code	Description	Price	Product	Article code	Description	Price
	DD-1800	Remote control 1 channel	€41,10		DC-202	Transformator 12V JST EU stijl	€19,90
	DD-2702	Remote control 15 channels	€37,90		DC-232W	Transformator 12V 5A EU met JST stekker	€32,50
	DD-2762	Remote control TDBU 15 channels	€39,50		DC-212	Charger 12V DIN EU style	€19,90
	DD-1862	Remote control TDBU 15 channels	€48,20		V4K5	Reducer 4k5	10 st. €3,85
	THB3115	Remote control 15 channels	€51,10		V6K5	Reducer 6k5	10 st. €3,85
	DD-1554	BREL HOME Hub USB WiFi dongle bi-directional	€120,-		V6K6	Reducer 6k6	10 st. €3,85
	DC-1201	12V Li-ion 950 mAh battery with 1x DIN 1x JST	€27,50		Z-75	Fixation for shaft	€0,85
	DC-1277	12V Li-ion 2600 mAh batterij met 1x DIN 1x JST	€52,50		Z-75-4K5	Fixation for shaft 4k5	10 st. €4,65
	Z-43-001	Three-way plug JST	€3,70		BP-24	Fixation bracket motor HD VB/PB headrail	€1,05
	Z-43-025 / 050 / 100 / 200 / 500	Extension cable with JST plugs	From €6,50		BP-VA	Fixation bracket Vako 20.04/ Coulisse/ Heditex-Valencia	10 st. €4,30



Notes

A series of horizontal dotted lines spanning the width of the page, intended for writing notes.



Project motors

Voltage-free switching	56
BJE24DD	57
BPE25DD	57
BEQ35DD	58
MS25	58
MDS25	59
MBQ35	59
MSW35	60
MSW45	60





Motor with Voltage-free switching

Specially made for Home Automation systems

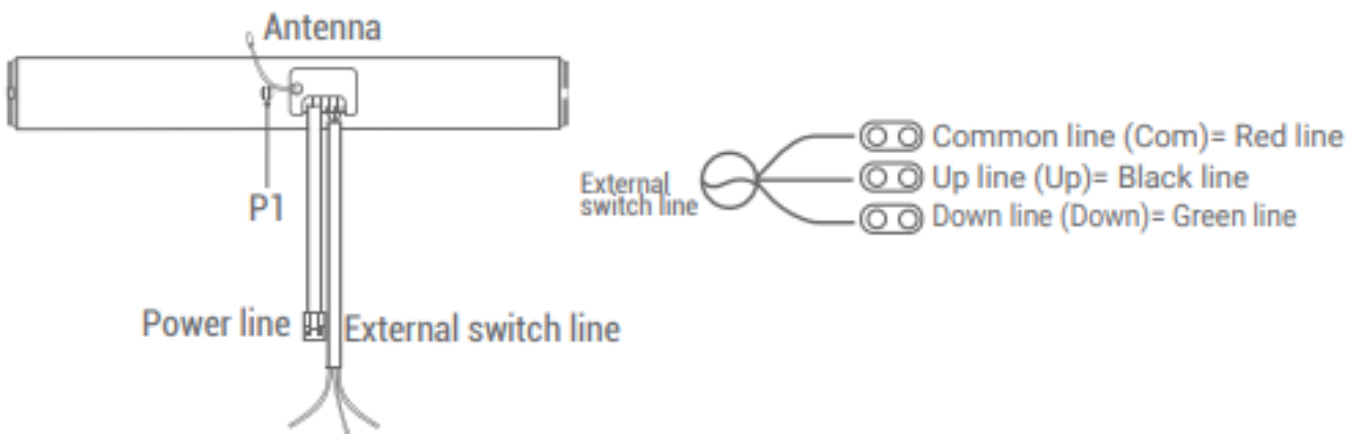

The BJE24DD motor is ideal for **projects** with indoor shading. Because the motor is equipped with an extra dry contact wire, it is very suitable for connection to home automation systems and building management systems. In addition, the motor is **easy to install** due to the bi-directional radio protocol.





BJE24DD

24mm 12V elektronische radio motor dubbelzijdige as met JST stekker en spanningsloze schakeling



- ⤴ Elektronische eindafstelling**
- ⤴ Tussenpositie**
- ⤴ Ingebouwde ontvanger**
- ⤴ Vermogenschakelaar**
- ⤴ Pulsbediening**
- ⤴ Zelfcentrerende as**

TECHNICAL SPECIFICATIONS

Articlecode	Torque (Nm)	Speed (RPM)	Diameter (MM)	Motor Length (MM)	Cable Length (CM)	Power (W)	Current (A)	Tension (V)	Water Resistance	Price (€)
BJE24DD-0.6	0.8	34	24	210	30	10	0.83	12	IP20	€136,50

BPE25DD

25mm 230V elektronische radio motor met spanningsloze schakeling



- ⤴ Elektronische eindafstelling**
- ⤴ Pulsbediening**
- ⤴ Ingebouwde ontvanger**
- ⤴ Tussenpositie**
- ⤴ 230V AC**
- ⤴ Vermogenschakelaar**
- ⤴ Extra sterke motor**

TECHNICAL SPECIFICATIONS

Articlecode	Torque (Nm)	Speed (RPM)	Diameter (MM)	Motor Length (MM)	Cable Length (CM)	Power (W)	Current (A)	Tension (V)	Water Resistance	Price (€)
BPE25DD-1.5	1.5	32	25	440	500	13	0.15	110-240	IP20	€119,90



BEQ35DD

35mm 230V silent electronic radio motor met spanningsloze schakeling



- ⤴ Electronic limit setting
- ⤴ Built-in receiver
- ⤴ 230V AC

- ⤴ Dot-move function
- ⤴ Preference position / third limit
- ⤴ Silent motor (54 db)

TECHNICAL SPECIFICATIONS

Articlecode	Torque (Nm)	Speed (RPM)	Diameter (MM)	Motor Length (MM)	Cable Length (CM)	Power (W)	Current (A)	Tension (V)	Water Resistance	Price (€)
BEQ35DD-10	10	17	35	590	500	155	0.67	230	IP44	€139,10

MS25

25mm 230V electronic standard motor



- ⤴ Electronic limit setting
- ⤴ 230V AC

- ⤴ Parallel switching
- ⤴ Max.90 per 16A fuse

TECHNICAL SPECIFICATIONS

Articlecode	Torque (Nm)	Speed (RPM)	Diameter (MM)	Motor Length (MM)	Cable Length (CM)	Power (W)	Current (A)	Tension (V)	Water Resistance	Price (€)
MS25-1.5	1.5	32	25	445	200	13	0.15	230	IP20	€113,50

MDS25

25mm 24V standard motor



- ⚡ Mechanic limit setting
- ⚡ 24V AC

⚡ Rollertube diameter must be min. 35 mm

TECHNICAL SPECIFICATIONS

Articlecode	Torque (Nm)	Speed (RPM)	Diameter (MM)	Motor Length (MM)	Cable Length (CM)	Power (W)	Current (A)	Tension (V)	Water Resistance	Price (€)
MDS25-0.7	0.7	28	25	320	200	8	0.3	24	IP20	€76,50

MBQ35

35mm 230V standard motor extra silent



- ⚡ Mechanic limit setting
- ⚡ 230V AC

⚡ Silent motor (54 db)

TECHNICAL SPECIFICATIONS

Articlecode	Torque (Nm)	Speed (RPM)	Diameter (MM)	Motor Length (MM)	Cable Length (CM)	Power (W)	Current (A)	Tension (V)	Water Resistance	Price (€)
MBQ35-06	6	28	35	550	300	121	0.53	230	IP44	€81,30
MBQ35-10	10	17	35	550	300	144	0.62	230	IP44	€85,40

MSW35

35 mm standard motor with moulded Hirschmann plug



- ⤴ Mechanic limit setting
- ⤴ 230V AC

- ⤴ Moulded plug
- ⤴ German or French connection

TECHNICAL SPECIFICATIONS

Articlecode	Torque (Nm)	Speed (RPM)	Diameter (MM)	Motor Length (MM)	Cable Length (CM)	Power (W)	Current (A)	Tension (V)	Water Resistance	Price (€)
MSW35-10D	10	17	35	476	30	121	0.53	230	IP44	€73,80
MSW35-10F	10	17	35	476	30	121	0.53	230	IP44	€76,80

MSW45

45 mm standard motor with moulded Hirschmann plug



- ⤴ Mechanic limit setting
- ⤴ 230V AC

- ⤴ Moulded plug
- ⤴ German or French connection

TECHNICAL SPECIFICATIONS

Articlecode	Torque (Nm)	Speed (RPM)	Diameter (MM)	Motor Length (MM)	Cable Length (CM)	Power (W)	Current (A)	Tension (V)	Water Resistance	Price (€)
MSW45-20D	20	15	45	476	30	145	0.64	230	IP44	€80,20
MSW45-20F	20	15	45	476	30	145	0.64	230	IP44	€82,50



Notes

A series of horizontal dotted lines for writing notes, spanning the width of the page.



Curtain track motors

BGLE-980	64
BG-980	64
BG-45	65
MGS45	65
Curtain tracks	66
Accessories	67





BGLE-980

12V electronic DC radio curtain motor



- ⬆️ Electronic and automatic limit setting
- ⬆️ Stall protection
- ⬆️ Built-in receiver
- ⬆️ Manual override
- ⬆️ Preference stop position
- ⬆️ Pluggable Lithium battery pack
- ⬆️ Automatic power off switch
- ⬆️ Dry Contact input

TECHNICAL SPECIFICATIONS

Articlecode	Torque (Nm)	Speed (RPM)	Diameter (MM)	Motor Length (MM)	Cable Length (CM)	Power (W)	Current (A)	Tension (V)	Water Resistance	Price (€)
BGLE-980	1.2	20	55	415	X	16	1.1	16	IP40	€259,00

BG-980

230V electronic radio Wifi curtain motor



- ⬆️ Electronic and automatic limit setting
- ⬆️ Stall protection
- ⬆️ Built-in receiver
- ⬆️ Manual override
- ⬆️ Preference stop position
- ⬆️ Dry Contact input
- ⬆️ Automatic power off switch
- ⬆️ Wifi function

TECHNICAL SPECIFICATIONS

Articlecode	Torque (Nm)	Speed (RPM)	Diameter (MM)	Motor Length (MM)	Cable Length (CM)	Power (W)	Current (A)	Tension (V)	Water Resistance	Price (€)
BG-980	0.8	20	55	250	500	45	0.23	230	IP40	€184,00

BG-45

230V electronic radio curtain motor



- ⤴ Electronic and automatic limit setting**
- ⤴ Manual override**
- ⤴ Built-in receiver**
- ⤴ Dry Contact input**
- ⤴ Stall protection**

TECHNICAL SPECIFICATIONS

Articlecode	Torque (Nm)	Speed (RPM)	Diameter (MM)	Motor Length (MM)	Cable Length (CM)	Power (W)	Current (A)	Tension (V)	Water Resistance	Price (€)
BG-45	0.8	20	70	215	500	45	0.20	230	IP40	€157,50

MGS45

230V standard curtain motor



- ⤴ Electronic limit setting**
- ⤴ For switch or Smart Home system**
- ⤴ Automatic power off switch**
- ⤴ Especially for projects**
- ⤴ With 5m cable**

TECHNICAL SPECIFICATIONS

Articlecode	Torque (Nm)	Speed (RPM)	Diameter (MM)	Motor Length (MM)	Cable Length (CM)	Power (W)	Current (A)	Tension (V)	Water Resistance	Price (€)
MGS45	0.8	23	70	215	500	45	0.23	230	IP40	€147,50

Curtain tracks

Prices excl. VAT and excl. Transport

S-Track

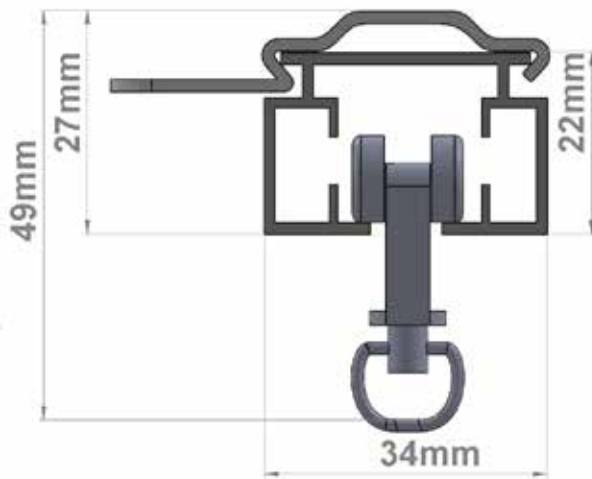

Slim-Track

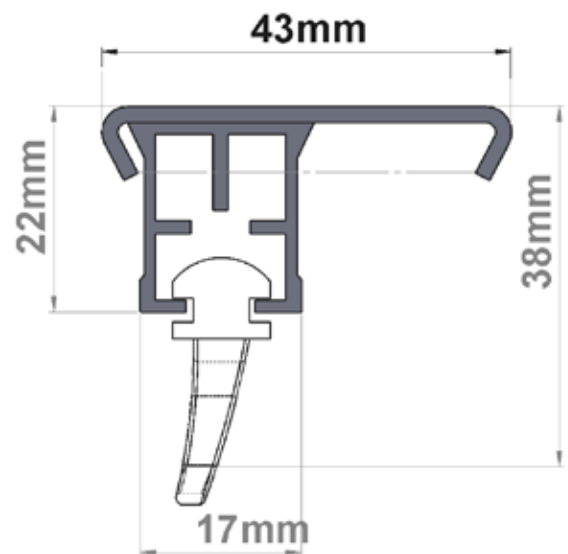

Width (cm)	S-Track	S-Track Wave	Slim-Track	Slim-Track Wave
200	€113,00	€166,00	€261,00	€316,00
300	€124,00	€192,00	€296,00	€354,00
400	€135,00	€219,00	€332,00	€396,00
500	€145,00	€247,00	€377,00	€454,00
600	€173,00	€284,00	€429,00	€502,00
700	€198,00	€328,00	€466,00	€553,00

The prices for the curtain tracks do not include motors and accessories.

Accessories

Product	Article code	Description	Price	Product	Article code	Description	Price
	DD-1852	Remote control Curtain 15 channels	€48,20		G-04	Component set MG(S)-45 & BG-45	€5,70
	DD-2752	Remote control Curtain 15 channels	€39,50		G-07	Wall bracket	€1,85
	DD-1554	BREL HOME Hub USB WiFi dongle bi-directional	€120,-		G-09	Cable with RJ11 plug for home automation	€11,75
	DD-7002B	BREL HOME Hub WiFi RS485	€145,-		G-10	Runner 12,6mm width	€0,40
	HUB-03	Charger EU style BGLE-980	€165,-		G-15	Ceilingclip S track	€0,60
	DC-216	Solar panel for curtains with XL DIN plug	€28,00		G-17	Wave-runner 60 mm	€6,20
	DC-1289G	Lightsensor for indoor mounting	€51,65		G-18	Wave-runner 80 mm	€9,30
	G-01	Curtain track 7m	€62,45		G-22-R	Component set horizontal right BG(LE)-980	€37,50
	G-02	Belt per 100 m	€675,00		G-22-L	Component set horizontal left BG(LE)-980	€37,50
	G-03	1e runner	€6,85		G-23	Component set vertical BG(LE)-980	€8,50



Standard motors

MS25	70
MDS25	71
MS35	72
MSD35	73
MBQ35	74
MSW35	76
MSW45	77
MS45	78
MS55	79
MH92	80



MS25

25mm 230V standard motor



- ⤴ Electronic limit setting
- ⤴ 230V AC

- ⤴ Parallel switching
- ⤴ Max.90 per 16A fuse





TECHNICAL SPECIFICATIONS

Articlecode	Torque (Nm)	Speed (RPM)	Diameter (MM)	Motor Length (MM)	Cable Length (CM)	Power (W)	Current (A)	Tension (V)	Water Resistance	Price (€)
MS25-0.8	0.8	32	25	445	200	13	0.15	230	IP20	€113,50

Crown and Wheels

&

Motorbrackets

Product	Article code	Description	Price	Product	Article code	Description	Price
	ABB29-25	Adaption Benthin tube 29	€2,40		ACC28-25	Adaption Coulisse tube 28	€2,40
	ABB32-25	Adaption Benthin tube 32	€2,40		ACC30-25	Adaption Coulisse tube 30	€2,40
	ABB38-25	Adaption Benthin tube 38	€2,40		ACC38-25	Adaption Coulisse tube 38	€2,40
	ABB43-25	Adaption Benthin tube 43	€2,40		ACC42-25	Adaption Coulisse tube 42	€2,40
	BRS-25	Motorbracket Benthin tube	€1,90		BRCCA-25	Motorbracket Coulisse tube	€2,40

MDS25

25mm 24V standard motor



- ⚡ Mechanic limit setting
- ⚡ 24V AC

⚡ Rollertube diameter must be min. 35 mm











TECHNICAL SPECIFICATIONS

Articlecode	Torque (Nm)	Speed (RPM)	Diameter (MM)	Motor Length (MM)	Cable Length (CM)	Power (W)	Current (A)	Tension (V)	Water Resistance	Price (€)
MDS25-0.7	0.7	28	25	320	200	8	0.3	24	IP20	€76,50

Adaptie

&

Motorbrackets

Product	Article code	Description	Price	Product	Article code	Description	Price
	AHD32-25	Adaption Hunter Douglas tube 32	€2,40		AL032-25	Adaption Louvolite tube 32	€2,40
	AHD34-25	Adaption Hunter Douglas tube 34	€2,40		AL035-25	Adaption Louvolite tube 35	€2,40
	AHD38-25	Adaption Hunter Douglas tube 38	€2,40		AL040-25	Adaption Louvolite tube 40	€2,40
	AHD40-25	Adaption Hunter Douglas tube 40	€2,40		AL045-25	Adaption Louvolite tube 45	€2,40
	BRS-25	Motorbracket HD tube	€1,90		BRL-32	Motorbracket Louvolite tube	€2,40

MS35

35mm standard motor



⤴ Mechanic limit setting

⤴ 230V AC

TECHNICAL SPECIFICATIONS

Articlecode	Torque (Nm)	Speed (RPM)	Diameter (MM)	Motor Length (MM)	Cable Length (CM)	Power (W)	Current (A)	Tension (V)	Water Resistance	Price (€)
MS35-10	10	17	35	476	300	121	0.53	230	IP44	€66,60
MS35-13	13	14	35	476	300	121	0.53	230	IP44	€70,20

Controls

&

Power supply

Product	Article code	Description	Price	Product	Article code	Description	Price
	DD-1680	Surface mounted receiver for wall socket with integrated switch	€49,25		Z-23-5	Plug with 5m 4-core wire STAK	€25,50
	DD-1690	Flush-mounted receiver for wall socket with integrated switch	€49,25		Z-23-10	Plug with 10m 4-core wire STAK	€29,80
	DD-50	Receiver according IP55	€41,80		Z-24	Hirschmann work plug clip STASI	€2,25
	Z-22	Plug STAS	€13,90		Z-40	250 cm cable and plug	€4,90
	Z-23	Plug STAK	€8,85		Z-44	Cable 4-core 0.75mm ² per 100m	€127,50

MSD35

35mm super short standard motor





- ⤴ Mechanic limit setting
- ⤴ 230V AC

- ⤴ Super short motor

TECHNICAL SPECIFICATIONS

Articlecode	Torque (Nm)	Speed (RPM)	Diameter (MM)	Motor Length (MM)	Cable Length (CM)	Power (W)	Current (A)	Tension (V)	Water Resistance	Price (€)
MSD35-10	10	17	35	396	300	121	0.53	230	IP44	€76,50

Crown and Wheels

Product	Article code	Description	Price
	A8K40-35	Adaption octagon 40 tube 35 mm motor	€1,80
	A40-35	Adaption 40 tube 35 mm motor	€1,60
	A41-35	Adaption octagon 41 tube 35 mm motor	€2,65
	A50-35	Adaption 50 tube 35 mm motor	€2,65
	AZ63C	Bung tube 63 for zipscreen	€3,15

Motorbrackets

Product	Article code	Description	Price
	A8K60/63-45	Adaption octagon 60/63 tube 45 mm motor	€2,65
	V35-45	Adaption from 35 mm to 45 mm motor	€0,85
	KR-35-S	Motorbracket 35mm standard motor	€2,65
	BR-45	Motorbracket for shutter max. 50Nm	€1,90
	BZ-45	Motorbracket for awnings max. 50Nm	€2,10

MBQ35

35mm silent motor



 **Mechanic limit setting**
 **230V AC**

 **Silent motor (54 db)**

TECHNICAL SPECIFICATIONS

Articlecode	Torque (Nm)	Speed (RPM)	Diameter (MM)	Motor Length (MM)	Cable Length (CM)	Power (W)	Current (A)	Tension (V)	Water Resistance	Price (€)
MBQ35-06	6	28	35	550	300	121	0.53	230	IP44	€81,30
MBQ35-10	10	17	35	550	300	144	0.62	230	IP44	€85,40

Controls

&

Power supply

Product	Article code	Description	Price	Product	Article code	Description	Price
	DD-1680	Surface mounted receiver for wall socket with integrated switch	€49,25		Z-23-5	Plug with 5m 4-core wire STAK	€25,50
	DD-1690	Flush-mounted receiver for wall socket with integrated switch	€49,25		Z-23-10	Plug with 10m 4-core wire STAK	€29,80
	DD-50	Receiver according IP55	€41,80		Z-24	Hirschmann work plug clip STASI	€2,25
	Z-22	Plug STAS	€13,90		Z-40	250 cm cable and plug	€4,90
	Z-23	Plug STAK	€8,85		Z-44	Cable 4-core 0.75mm ² per 100m	€127,50



Notes

A series of horizontal dotted lines for writing notes, spanning the width of the page.

MSW35

35 mm standard motor with moulded Hirschmann plug



- ⤴ Mechanic limit setting
- ⤴ 230V AC

- ⤴ Moulded plug
- ⤴ German or French connection

Type	Connection	1	2	3	4
D	German	Blue	Brown	Black	Yellow/Green
F	French	Brown	Blue	Black	Yellow/Green

TECHNICAL SPECIFICATIONS

Articlecode	Torque (Nm)	Speed (RPM)	Diameter (MM)	Motor Length (MM)	Cable Length (CM)	Power (W)	Current (A)	Tension (V)	Water Resistance	Price (€)
MSW35-10D	10	17	35	476	30	121	0.53	230	IP44	€73,80
MSW35-10F	10	17	35	476	30	121	0.53	230	IP44	€76,80

Controls

&

Power supply

Product	Article code	Description	Price	Product	Article code	Description	Price
	DC-134	Relay box for 4 motors	€41,50		Z-23-5	Plug with 5m 4-core wire STAK	€25,50
	DC-209	Connector centralized control	€31,50		Z-23-10	Plug with 10m 4-core wire STAK	€29,80
	DD-50	Receiver according IP55	€41,80		Z-24	Hirschmann work plug clip STASI	€2,25
	Z-22	Plug STAS	€13,90		Z-40	250 cm cable and plug	€4,90
	Z-23	Plug STAK	€8,85		Z-44	Cable 4-core 0.75mm2 per 100m	€127,50

MSW45

45 mm standard motor with moulded Hirschmann plug



- ⤴ Mechanic limit setting
- ⤴ 230V AC





- ⤴ Moulded plug
- ⤴ German or French connection

Type	Connection	1	2	3	4
D	German	Blue	Brown	Black	Yellow/Green
F	French	Brown	Blue	Black	Yellow/Green



TECHNICAL SPECIFICATIONS

Articlecode	Torque (Nm)	Speed (RPM)	Diameter (MM)	Motor Length (MM)	Cable Length (CM)	Power (W)	Current (A)	Tension (V)	Water Resistance	Price (€)
MSW45-20D	20	15	45	476	30	145	0.64	230	IP44	€80,20
MSW45-20F	20	15	45	476	30	145	0.64	230	IP44	€82,50

Crown and Wheels

Product	Article code	Description	Price
	A8K40-35	Adaption octagon 40 tube 35 mm motor	€1,80
	A40-35	Adaption 40 tube 35 mm motor	€1,60
	A41-35	Adaption octagon 41 tube 35 mm motor	€2,65
	A50-35	Adaption 50 tube 35 mm motor	€2,65
	AZ63C	Bung tube 63 for zipscreen	€3,15

Motorbrackets

Product	Article code	Description	Price
	A8K60/63-45	Adaption octagon 60/63 tube 45 mm motor	€2,65
	V35-45	Adaption from 35 mm to 45 mm motor	€0,85
	KR-35-S	Motorbracket 35mm standard motor	€2,65
	KR-45	Motorbracket 45 mm crown	€4,50
	BZ-45	Motorbracket for awnings max. 50Nm	€2,10

MS45

45 mm standard motor



⤴ Mechanic limit setting

⤴ 230V AC

TECHNICAL SPECIFICATIONS

Articlecode	Torque (Nm)	Speed (RPM)	Diameter (MM)	Motor Length (MM)	Cable Length (CM)	Power (W)	Current (A)	Tension (V)	Water Resistance	Price (€)
MS45-20	20	15	45	476	300	145	0.64	230	IP44	€66,70
MS45-40	40	15	45	540	300	198	0.86	230	IP44	€73,20

Crown and Wheels

&

Motorbrackets

Product	Article code	Description	Price	Product	Article code	Description	Price
	A8K60/63-45	Adaption octagon 63 tube 45 mm motor	€2,65		A79-45	Adaption 79 tube 45 mm motor	€3,55
	A63-45	Adaption 63 tube 45 mm motor	€4,45		A85-45	Adaption 85 tube 45 mm motor	€5,20
	A8K70-45	Adaption octagon 70 tube 45 mm motor	€4,45		A100-45	Adaption 100 tube 45 mm motor	€14,45
	A70-45	Adaption 70 tube 45 mm motor	€4,45		KR-45	Motorbracket 45 mm crown	€4,50
	A78-45	Adaption 78 tube 45 mm motor	€4,25		BZ-45	Motorbracket for awnings max. 50Nm	€2,10

MS55

55 mm standard motor



- ⤴ Mechanic limit setting
- ⤴ 230V AC

- ⤴ Centered in tube 85





TECHNICAL SPECIFICATIONS

Articlecode	Torque (Nm)	Speed (RPM)	Diameter (MM)	Motor Length (MM)	Cable Length (CM)	Power (W)	Current (A)	Tension (V)	Water Resistance	Price (€)
MS55-60	60	12	55	561	300	320	1.39	230	IP44	€133,00
MS55-80	80	12	55	572	300	385	1.65	230	IP44	€140,00
MS55-120	120	7	55	581	300	393	1.68	230	IP44	€158,00

Crown and Wheels

Product	Article code	Description	Price
	A8K70-55	Adaption octagon 70 tube 55 mm motor	€6,20
	A78-55	Adaption 78 tube 55 mm motor	€5,80
	A85-55	Adaption 85 tube 55 mm motor	€5,70
	A100-55	Adaption 100 tube 55 mm motor	€19,70
	A8K112-55	Adaption octagon 112 tube 55 mm motor	€7,00

Controls - Power supply

Product	Article code	Description	Price
	DD-1680	Surface mounted receiver for wall socket with integrated switch	€49,25
	DD-1690	Flush-mounted receiver for wall socket with integrated switch	€49,25
	DD-50	Receiver according IP55	€41,80
	Z-44	Cable 4-core 0.75mm ² per 100m	€127,50
	Z-23-5	Plug with 5m 4-core wire STAK	€25,50

MH92

92 mm standard motor with manual override





- ⤴ Mechanic limit setting
- ⤴ 230V AC

- ⤴ Manual override

TECHNICAL SPECIFICATIONS

Articlecode	Torque (Nm)	Speed (RPM)	Diameter (MM)	Motor Length (MM)	Cable Length (CM)	Power (W)	Current (A)	Tension (V)	Water Resistance	Price (€)
MH92-300	300	9	92	551	300	940	4.08	230	IP44	€468,00

Crown and Wheels

Product	Article code	Description	Price
	A100-92	Adaption 100 tube 92mm motor	€17,30
	A107-92	Adaption 107 tube 92mm motor	€26,00
	A125-92	Adaption 125 tube 92mm motor	€29,20
	A160-92	Adaption 160 tube 92mm motor	€31,90

Controls - Power supply

Product	Article code	Description	Price
	DD-1680	Surface mounted receiver for wall socket with integrated switch	€49,25
	DD-1690	Flush-mounted receiver for wall socket with integrated switch	€49,25
	DD-50	Receiver according IP55	€41,80
	Z-44	Cable 4-core 0.75mm ² per 100m	€127,50
	Z-40	250cm cable and plug	€4,90



Notes

A series of horizontal dotted lines for writing notes, spanning the width of the page.

Motorhead drawings

Specifications of the motorhead 15mm and 20mm

15mm motors

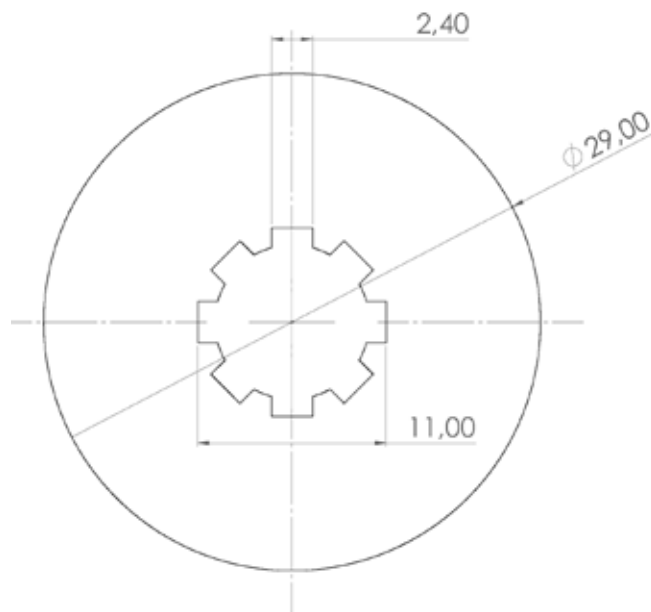

20mm motors

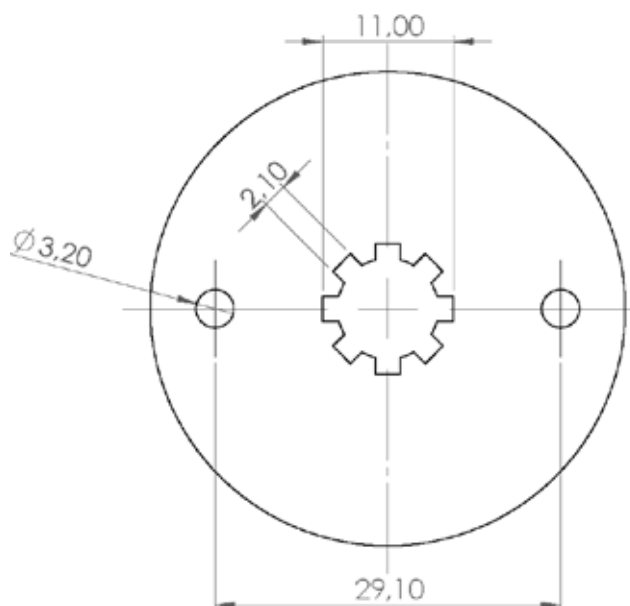

Motorhead drawings

Specifications of the motorhead 25mm and 28mm

25mm motors

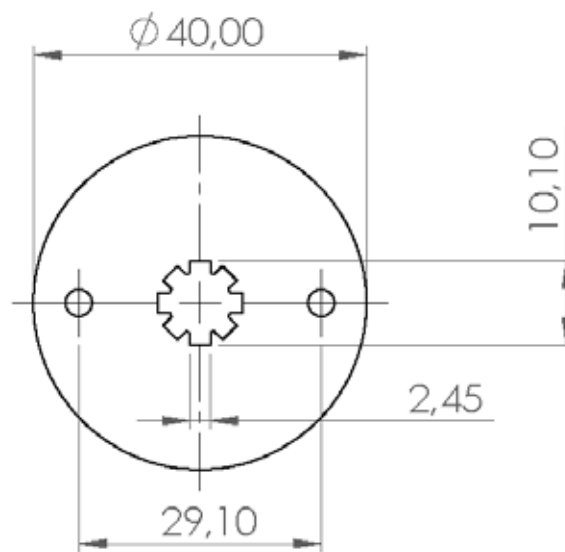

28mm motors

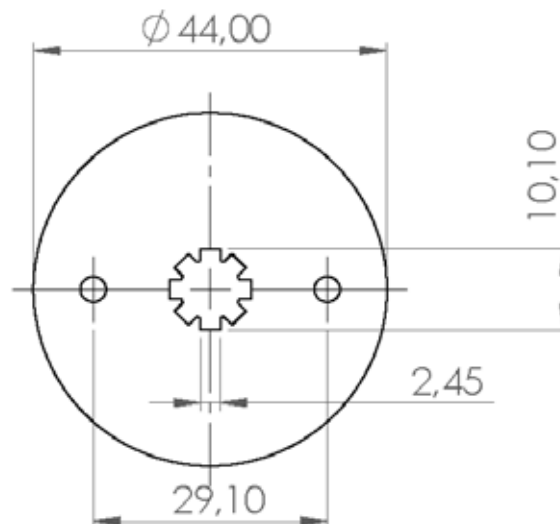

Motorhead drawings

Specifications of the motorhead 35mm and 45mm

35mm motors

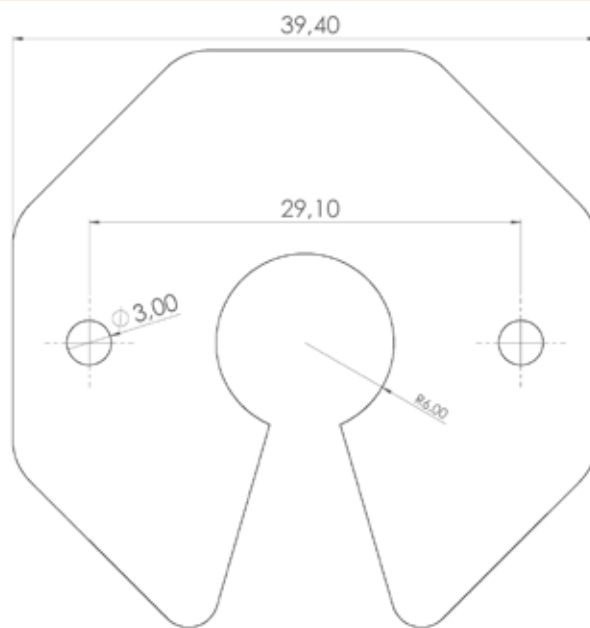

45mm motors

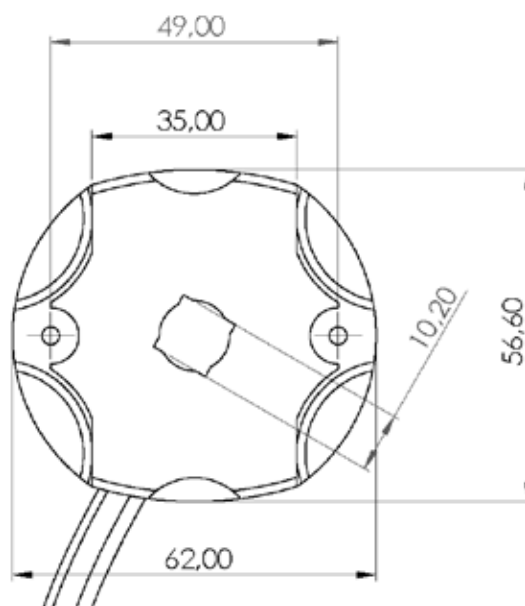



Notes

A series of horizontal dotted lines spanning the width of the page, intended for writing notes.



16:05

Scene

Edit

2 Timers 8 Scenes

Solar screen
1 Device

Ochtend zon
1 Device

Jaloezie avond
3 Devices

Open office
10 Devices

Hal open
8 Devices



Remote controls

Luxury remote controls	88
Standard remote controls	90
Basic remote controls	92
Other controls	93







Remote controls

Luxury

Product	Article code	Description	Price
	THB3001	Remote control 1 channel Battery type: CR2450	€45,55
	THB3015	Remote control 15 channels Battery type: CR2450	€51,10
	THB3115	Remote control 15 channels Battery type: CR2450	€51,10
	DD-1800	Remote control 1 channel Battery type: CR2450	€41,10
	DD-1802	Remote control 15 channels Battery type: CR2450	€46,10

Remote controls

Luxury

Product	Article code	Description	Price
	DD-1805	Remote control with timer 5 channels Battery type: CR2450	€63,60
	DD-1852	Remote control Curtain 15 channels Battery type: CR2450	€48,20
	DD-1862	Remote control TDBU 15 channels Battery type: CR2450	€48,20
	DD-1870	Wall remote 1 channel Battery type: CR2032	€39,60
	DD-1873	Wall remote 15 channels Battery type: CR2032	€45,10

Remote controls

Standard

Product	Article code	Description	Price
	DD-2700	Remote control 1 channel Battery type: CR2450	€32,50
	DD-2702	Remote control 15 channels Battery type: CR2450	€37,90
	DD-2705	Remote control with timer 5 channels Battery type: CR2450	€53,50
	DD-2710	Remote control Tilt & Lift 1 channel Battery type: CR2450	€36,90
	DD-2712	Remote control Tilt & Lift 15 channels Battery type: CR2450	€39,50

Remote controls

Standard

Product	Article code	Description	Price
	DD-2752	Remote control Curtain 15 channels Battery type: CR2450	€39,50
	DD-2762	Remote control TDBU 15 channels Battery type: CR2450	€39,50
	DD-2770	Wall remote 1 channel Battery type: CR2032	€29,20
	DD-2773	Wall remote 15 channels Battery type: CR2032	€34,50

Remote controls

Basic

Product	Article code	Description	Price
	DD-250	Remote control 1 channel Battery type: CR2450	€20,40
	DD-251	Remote control 5 channels Battery type: CR2450	€23,50
	DD-2291	Mini remote control	€21,50
	DD-115	Mini remote control	€21,50

Other controls

Product	Article code	Description	Price
	DD-7002B	BREL HOME Hub WiFi RS485	€145,00
	HUB-03	BREL HOME Hub WiFi UTP/PoE	€165,00
	DD-1554	BREL HOME Hub USB WiFi dongle bi-directional	€120,00
	DD-1557	Repeater	€26,50
	DD-1680	Surface mounted receiver for wall socket with integrated switch	€49,25
	DD-1690	Flush-mounted receiver for wall socket with integrated switch	€49,25

Other controls

Product	Article code	Description	Price
	DD-116	Sun- and wind meter 230V	€68,40
	DD-117	Dry contact receiver for home automation	€47,10
	DD-118	Sun- and wind meter wireless	€81,50
	DD-1149	Dry contact remote for home automation	€31,30
	DD-50	Receiver according IP55	€41,80
	DD-510	Shock sensor	€55,80



Accessories

Power supply USB	98
Power supply JST	100
Power supply DIN	102
Solar panels	105
Other power supplies	106
Crown and Wheels + customized crown and wheels	108
Motorbrackets	118
Other accessories	121



Power supply

USB

Product	Article Code	Description	Price
	Z-42-300M	USB cable 3m with magnet	€7,75
	Z-47-200M-B	Magnetic cable 3m male Micro USB to magnet	€8,90
	Z-47-300F-W	Cable 3m female micro USB to USB	€8,90
	Z-47-300M-B	Magnetic cable 3m male Micro USB to magnet	€9,50
	Z-48-002	Adapter plug from micro USB female to USB-C male	€8,50
	Z-48-004	Adapter plug from USB-C female to Micro USB male	€8,50
	Z-48-005	USB-C charging point with fastening nut extension cable black USB-C plug 5cm	€8,50
	Z-48-200M-B	Magnetic cable 2m male USB-C to magnet	€9,50

Power supply

USB

Product	Article Code	Description	Price
	Z-48-300	Cable 3m white USB-A and USB-C	€11,50
	Z-48-300M-B	Magnetic cable 3m male USB-C to magnet	€8,90
	Z-42-01	Magnetic plug Micro USB	€1,20
	Z-42-02	Magnetic plug USB-C	€2,20
	Z-42-027	USB cable with angled plug 27 cm	€3,60
	DC-220	USB Charger EU style	€12,70
	DC-221	USB Charger UK style	€12,70
	DC-222	USB Charger US style	€18,70







Power supply

JST

Product	Article Code	Description	Price
	Z-43-001	Three-way plug JST	€3,70
	Z-43-002	Plug adaptor from JST to DIN plug	€3,70
	Z-43-025	25 cm extension wire with JST plugs	€6,50
	Z-43-050	50 cm extension wire with JST plugs	€6,50
	Z-43-100	100 cm extension wire with JST plugs	€7,00
	Z-43-200	200 cm extension wire with JST plugs	€7,50
	Z-43-500	500 cm extension wire with JST plugs	€9,50
	DC-1201	Battery 12V 950 mAh 1x DIN 1x JST 105mm x 24mm	€27,50





Power supply

JST

Product	Article Code	Description	Price
	DC-1277	Battery 12V 2600 mAh 1x DIN 1x JST 245mm x 30mm x 30mm	€52,50
	DC-1277B	Battery 12V 2600 mAh 1x DIN 1x JST 245mm x 30mm x 30mm	€52,50
	DC-1329	Battery 12V Li-ion 650 mAh 1x DIN 1x JST 130mm x 30mm	€39,50
	DC-201	Transformer 12V JST US style	€19,90
	DC-202	Transformer 12V JST EU style	€19,90
	DC-203	Transformer 12V JST UK style	€19,90
	DC-232W	Transformer 12V, 5A EU with JST plug	€32,50

Power supply

DIN

Product	Article Code	Description	Price
	Z-41-001	Three-way plug DIN	€3,70
	Z-41-002	Plug adaptor from DIN to JST plug	€3,70
	Z-41-025	25 cm extension wire with DIN plugs	€6,50
	Z-41-050	50 cm extension wire with DIN plugs	€6,50
	Z-41-100	100 cm extension wire with DIN plugs	€7,00
	Z-41-200	200 cm extension wire with DIN plugs	€7,50
	Z-41-500	500 cm extension wire with DIN plugs	€10,55
	Z-46-001	Three-way plug DIN for Solar	€5,70

Power supply

DIN





Product	Article Code	Description	Price
	Z-46-005	DIN charging point with fixing nut extension cable black screwable DIN plug 5cm	€8,50
	Z-46-025	25 cm extension wire with DIN plugs for Solar	€8,50
	Z-46-050	50 cm extension wire with DIN plugs for Solar	€8,50
	Z-46-100	100 cm extension wire with DIN plugs for Solar	€8,50
	Z-46-200	200 cm extension wire with DIN plugs for Solar	€9,50
	Z-46-500	500 cm extension wire with DIN plugs for Solar	€11,50
	DC-1293	Battery 12V 5100 mAh for BCE motor	€116,40
	DC-212	Charger 12V DIN EU style	€19,90

Power supply

DIN



Product	Article Code	Description	Price
	DC-213	Charger 12V DIN UK style	€19,90
	DC-200	Charger 12V DIN US style	€19,90
	DC-210	Transformer 12V DIN EU style	€19,90
	DC-211	Transformer 12V DIN UK style	€19,90
	DC-216	Charger EU style BGLE-980	€28,00
	DC-217	Charger UK style BGLE-980	€28,00

Solar panels

Product	Article Code	Description	Price
	DC-1288	Solar panel with micro USB, without housing 400x50x8mm	€66,70
	DC-1289G	Solar panel for BGLE-980 400x50x8mm	€51,65
	NC-1290	Solar panel with waterproof DIN plug, black housing 554x60x10mm	€53,95
	NC-1291	Solar panel with waterproof DIN plug without housing 530x56x3mm	€53,95
	NC-1295	Zonnepaneel met waterdichte DIN plug, zwarte behuizing 1085x60x10mm	€114,50
	NC-1297	Solar panel with waterproof DIN plug, black housing 750x40x13mm	€75,95





Power supply

Other

Product	Article Code	Description	Price
	Z-22	Plug STAS	€13,90
	Z-23	Plug STAK	€8,85
	Z-23-3	Plug with 3m 4-core wire STAK	€15,20
	Z-23-5	Plug with 5m 4-core wire STAK	€25,50
	Z-23-10	Plug with 10m 4-core wire STAK	€29,80
	Z-24	Hirschmann work plug clip STASI	€2,25
	Z-25	Limit setting cabel	€14,30
	Z-33	3-core wire 0.75mm ² per 100 m	€112,50

Power supply

Other

Product	Article Code	Description	Price
	Z-44	4-core wire 0.75mm ² per 100 m	€127,50
	Z-40	250 cm cable and plug	€4,90
	DC-2032	Battery type CR2032 3V	€3,40
	DC-2430	Battery type CR2430 3V	€3,40
	DC-2450	Battery type CR2450 3V	€4,20

Crown and Wheels

Accessories

Product	Article Code	Description	Price
	AZ50-35	Adaption zipscreen 50 tube <i>AZ50C + A50-35W</i>	€6,30
	AZ63-45	Adaption zipscreen 63 tube <i>AZ63C + A8K60/63-45W</i>	€5,00
	AZ78-45	Adaption zipscreen 78 tube <i>AZ78C + A70-45W</i>	€7,10
	DZ-63	Bung 'no-motor side' ZIP 63 tube	€3,10
	A8K40-25	Adaption octagon 40 tube 25 mm motor <i>A8K40-25C + A8K40-25W</i>	€2,55
	A8K40-28	Adaption octagon 40 tube 28 mm motor <i>A8K40-28C + A8K40-28W</i>	€2,55
	A40-35	Wheel 40 tube	€1,60
	V35-45	Adaption 35mm to 45mm motor	€0,85

Crown and Wheels

Accessories

Product	Article Code	Description	Price
	A8K40-35	Adaption octagon 40 tube 35 mm motor A8K40-35C + A8K40-35W	€1,80
	A41-35	Adaption 41 tube 35 mm motor A41-35C + A41-35W	€2,65
	A50-35	Adaption 50 tube 35 mm motor A50-35C + A50-35W	€2,65
	A8K50-45	Adaption octagon 50 tube 45 mm motor A8K50-45C + A8K50-45W	€2,65
	A8K60/63-45	Adaption octagon 60/63 tube 45 mm motor A8K60/63-45C + A8K60/63-45W	€2,65
	A63-45	Adaption 63 tube 45 mm motor A63-45C + A63-45W	€4,45
	A70-45	Adaption 70 tube 45 mm motor A70-45C + A70-45W	€4,45
	A8K70-45	Adaption octagon 70 tube 45 mm motor A8K70-45C + A8K70-45W	€4,45

Crown and Wheels

Accessories

Product	Article Code	Description	Price
	A78-45	Adaption 78 tube 45 mm motor A78-45C + A78-45W	€4,25
	A79-45	Adaption 79 tube 45 mm motor A79-45C + A79-45W	€3,55
	A85-45	Adaption 85 tube 45 mm motor A85-45C + A85-45W	€5,20
	A100-45	Adaption 100 tube 45 mm motor A100-45C + A100-45W	€14,45
	A8K70-55	Adaption octagon 70 tube 55 mm motor A8K70-55C + A8K70-55W	€6,20
	A78-55	Adaption 78 tube 55 mm motor A78-55C + A78-55W	€5,80
	A85-55	Adaption 85 tube 55 mm motor A85-55C + A85-55W	€5,70
	A100-55	Adaption 100 tube 55 mm motor A100-55C + A100-55W	€19,70

Crown and Wheels

Accessories

Product	Article Code	Description	Price
	A110-55	Adaption 110 tube 55 mm motor A110-55C + A110-55W	€25,80
	A8K112-55	Adaption octagon 112 tube 55 mm motor A8K112-55C + A8K112-55W	€7,00
	A100-92	Adaption 100 tube 92 mm motor A100-92C + A100-92W	€17,30
	A107-92	Adaption 107 tube 92 mm motor A107-92C + A107-92W	€26,00
	A125-92	Adaption 125 tube 92 mm motor A125-92C + A125-92W	€29,20
	A160-92	Adaption 160 tube 92 mm motor A160-92C + A160-92W	€31,90
	V55-59	Adaption from 55 mm to 59 mm motor	€1,80
	V4K5	Reducer 4k5	10 st. €3,85

Crown and Wheels

Accessories

Product	Article Code	Description	Price
	V6K6	Reducer 6k6	10 st. €3,85
	V6K5	Reducer 6k5	10 st. €3,85
	V4K5-VA	Reducer 4k5 Vako	10 st. €4,30
	V-HD-R5	Reducer 4k5 for HD	10 st. €4,55
	AZ63C	Bung tube 63 for zipscreen	€3,15
	AZ78C	Bung tube 78 motor side for zipscreen	€4,00
	AZF54-45C	Crown Feller ZF54 45mm motor	€0,84
	AZF54-45W	Wheel Feller ZF54 45mm motor	€1,92



Notes

A series of horizontal dotted lines for writing notes, spanning the width of the page.



Customized crown and Wheels

Accessories

Benthin						
Motor	15mm motor	20mm motor	25mm motor	28mm motor	35mm motor	Price
alu 20	ABB20-15					€1,90
alu 20R	ABBR20R-15					€1,90
alu 29	ABB29-15	ABB29-22	ABB29-25			€2,40
alu 29R	ABBR29R-15	ABBR29R-22	ABBR29R-25			€2,40
alu 32		ABB32-22	ABB32-25			€2,40
alu 38		ABB38-22	ABB38-25	ABB38-28		€2,40
alu 43			ABB43-25	ABB43-28		€2,40
alu 44			ABB44-25	ABB44-28	ABB44-35	€2,40
alu 52			ABB52-25	ABB52-28	ABB52-35	€3,40
alu 65 SL				ABB65S-28	ABB65S-35	€3,80
alu 65				ABB65-28	ABB65-35	€3,80
Motorbracket	BRS-25M	BRS-22	BRS-25	BRS-28	BRS-35	€1,90

Hunter Douglas						
Motor	15mm motor	20mm motor	25mm motor	28mm motor	35mm motor	Price
staal 32.6	AHD32-15	AHD32-22	AHD32-25			€1,90
staal 36.9		AHD38-22	AHD38-25	AHD38-28		€2,40
alu 34.2		AHD34-22	AHD34-25			€2,40
alu 40.2			AHD40-25	AHD40-28		€2,40
alu 53.2			AHD50-25	AHD50-28	AHD50-35	€2,40
Motorbracket	BRS-25	BRS-22	BRS-25	BRS-28	BRS-35	€1,90



Customized crown and Wheels

Accessories

Coulisse

Motor	15mm motor	20mm motor	25mm motor	28mm motor	35mm motor	Price
alu 25	ACC25-15	ACC25-22				€1,90
alu 28	ACC28-15	ACC28-22	ACC28-25			€2,40
alu 30	ACC30-15	ACC30-22	ACC30-25			€2,40
alu 35		ACC35-22	ACC35-25			€2,40
alu 38		ACC38-22	ACC38-25	ACC38-28		€2,40
alu 42		ACC42-22	ACC42-25	ACC42-28	ACC42-35*	€2,40
alu 50			ACC50-25	ACC50-28	ACC50-35	€3,40
alu 65				ACC65-28	ACC65-35	€3,80
alu 80				ACC80-28	ACC80-35	€4,20
Motorbracket	BRCCA-25	BRCCA-22	BRCCA-25	BRCCA-28	BRCCA-35	€1,90

NOTE: The ACC42-35 set contains the ACC42-35W and the ACC42-35BE-C or ACC42-35ME-C. The ACC42-35BE-C is suitable for the electronic bi-directional motors and the ACC42-35ME-C is suitable for the electronic mono-directional motors.

Louvolite

Motor	15mm motor	20mm motor	25mm motor	28mm motor	Price	Motor bracket
alu 32	AL032-15	AL032-22	AL032-25		€1,90	BRL-32
alu 35		AL035-22	AL035-25		€2,40	BRL-40
alu 40		AL040-22	AL040-25	AL040-28	€2,40	BRL-45
alu 45-2L			AL045-25	AL045-28	€2,40	BRL-45
alu 45-3L			AL045S-25	AL045S-28	€2,40	
						€2,40



Customized crown and Wheels

Accessories

Decora						
Motor	15mm motor	20mm motor	25mm motor	28mm motor	Price	Motor bracket
Prime Roller tube 32	AL032-15	AL032-22			€1,90	BRL-32
Prime Roller tube 40		AL040-22	AL040-25	AL040-28	€2,40	BRL-40
Prime Roller tube 45-2			AL045-2-25	AL045-2-28	€2,40	BRL-45
Prime Roller tube 45-3			AL045-3-25	AL045-3-28	€2,40	BRL-45
						€2,40
Vako						
Motor	20mm motor	25mm motor	28mm motor	35mm motor	Price	
20/12				AVA44-35	€1,90	
50/17 tube 30	AVA30-20	AVA30-25			€2,40	
50/17 tube 38		AVA38-25	AVA38-28		€2,40	
50/17 tube 43			AVA43-28	AVA43-35	€2,40	
50/17 tube 50				AVA50-35	€2,40	
50/20 tube 38T		AVA38T-25	AVA38(T)-28		€2,40	
50/20 tube 38S		AVA38T-25	AVA38T-28		€2,40	
Motorbracket	BRS-25	BRS-25	BRS-25	BRS-35	€1,90	











Notes

A series of horizontal dotted lines for writing notes, spanning the width of the page.





Motorbrackets

Accessories

Product	Article Code	Description	Price
	BP-24	Fixation bracket motor HD VB/PB head	€1,05
	BP-29	Fixation bracket 29 mm headrail	€1,25
	BP-30	Fixation bracket 30 mm headrail	€1,25
	BP-VA	Fixation bracket Vako 20.04/ Coulisserie/ Heditex-Valencia	10 st. €4,30
	BW-35	Motor shaft 35 mm motor	€1,90
	KR-35-E	Motorbracket 35 mm for electrical motors	€2,65
	KR-35-S	Motorbracket 35 mm for standard motors	€2,65
	KR-45	Motorbracket 45 mm crown	€4,50

Motorbrackets

Accessories

Product	Article Code	Description	Price
	KR-137	Square support 45mm motor with hole	€3,35
	KR-150	Motorbracket for awnings max. 50 Nm	€3,35
	KR-165	Motorbracket square 13 max. 120 Nm	€3,35
	KR-180	Motorbracket for screen 75	€3,35
	KR-205	Motorbracket for screen 85	€3,35
	BR-45	Motorbracket for shutter max. 50 Nm	€1,90
	BZ-45	Motorbracket for awnings max. 50 Nm	€2,10
	BZ-55	Motorbracket square 13 max. 120 Nm	€2,10

Motorbrackets

Accessories

Product	Article Code	Description	Price
	BR-75	Motorbracket for screen 75	€1,05
	BR-85	Motorbracket for screen 85	€1,35
	BR-95	Motorbracket for screen 95	€1,35
	BR-137	Motorbracket shutter 137 max. 30 Nm	€3,35
	BR-150	Motorbracket shutter 150 max. 30 Nm	€3,35
	BR-165	Motorbracket shutter 165 max. 30 Nm	€3,35
	BR-180	Motorbracket shutter 180 max. 30 Nm	€3,35
	BR-205	Motorbracket shutter 205 max. 30 Nm	€3,35

Other

Accessories

Product	Article Code	Description	Price
	BRS-25M	Motorbracket metal for 20, 25, 28mm motor	€1,90
	BRL-40	Motorbracket Louvolite	€2,40
	BRL-45	Motorbracket Louvolite	€2,40
	VC-W1	Conus for 8k40 tube	€1,85
	VC-W2B	Container 50 mm tube holder Black	€1,90
	VC-W2W	Container 50 mm tube holder White	€1,90
	VC-W2G	Container 50 mm tube holder Grey	€1,90
	VP-8K40	Tube plug with shaft 8k40 tube	€2,30

Other

Accessories

Product	Article Code	Description	Price
	BP-52	Motorbracket round 35 mm motor for venetian blinds	€1,60
	BP-52-2	Motorbracket square 35 mm motor for venetian blinds	€1,60
	BP-HE-MA-1277	Battery bracket DC1277 for Madrid rail	€1,90
	BP-HE-VA-1277	Battery bracket DC1277 for Valencia rail	€1,90
	BVC-DIB-B	Charging plug holder headrail Black	€2,40
	BVC-DIB-W	Charging plug holder headrail White	€2,40
	BR-1290	Bracket for mounting NC-1290 set of 2 pieces	€4,75
	V35-SO V45-SO	Reducing ring 35 mm or 45 mm for Somfy adaptation	From €1,25

Other

Accessories

Product	Article Code	Description	Price
	H-Lagerblok-9999	Bearing Carré 95 with plate	€4,60
	H-Plaatje-Carré	Metal plate Carré 95	€0,55
	H-Topstuk-9001/9010/9999/ANO	Armbracket headrail	€7,20
	H-Windvast-9001/9010/9999/ANO	Droparm with spring	€32,50
	L-CM-9001/9010/9999/ANO	Wallbracket Carré 95 with helix	€4,20
	V-A12-30	Bearing pin 12mm 30mm long	€2,20
	V-A12-50	Bearing pin 12mm 50mm long	€2,40
	BW-45	Motor shaft 45 mm motor	€1,90

Other

Accessories

Product	Article Code	Description	Price
	VAS35-HE-95	Cover plate for cable 35mm Solar motor Heroal screen 95	€2,40
	VAS35-HE-105	Cover plate for cable 35mm Solar motor Heroal screen 105	€2,40
	VAS45- AVZ-95	Cover plate for cable 45mm Solar motor AVZ screen 95	€3,10
	VAS45-HE-95	Cover plate for cable 45mm Solar motor Heroal screen 95	€3,10
	VAS45-HE-105	Cover plate for cable 45mm Solar motor Heroal screen 105	€3,10
	VAS45-HE-125	Cover plate for cable 45mm Solar motor Heroal screen 125	€3,50
	VH-2	Spring roller shutter 2-piece	€5,25
	VH-3	Spring roller shutter 3-piece	€5,80

Other

Accessories

Product	Article Code	Description	Price
	V25-35	Plug for 25mm motor to 35mm	€1,25
	Z-55	Clip for 35mm and 45mm motor	€0,85
	Z-56	Clip for 16mm and 25mm motor	€0,25
	Z-57	Shaft for 25mm motor	€3,20
	Z-75	Fixation for shaft	€0,85
	Z-75-4K5	Fixation for shaft 4k5	€4,65
	Z-67	Flush-mounted box for DD-1680	€2,00
	Z-68	Flush-mounted box for DC-227	€2,00



Smart Home Solutions

Control with the BREL HOME app	128
Control with a Home Automation system	129





Control with the BREL HOME app

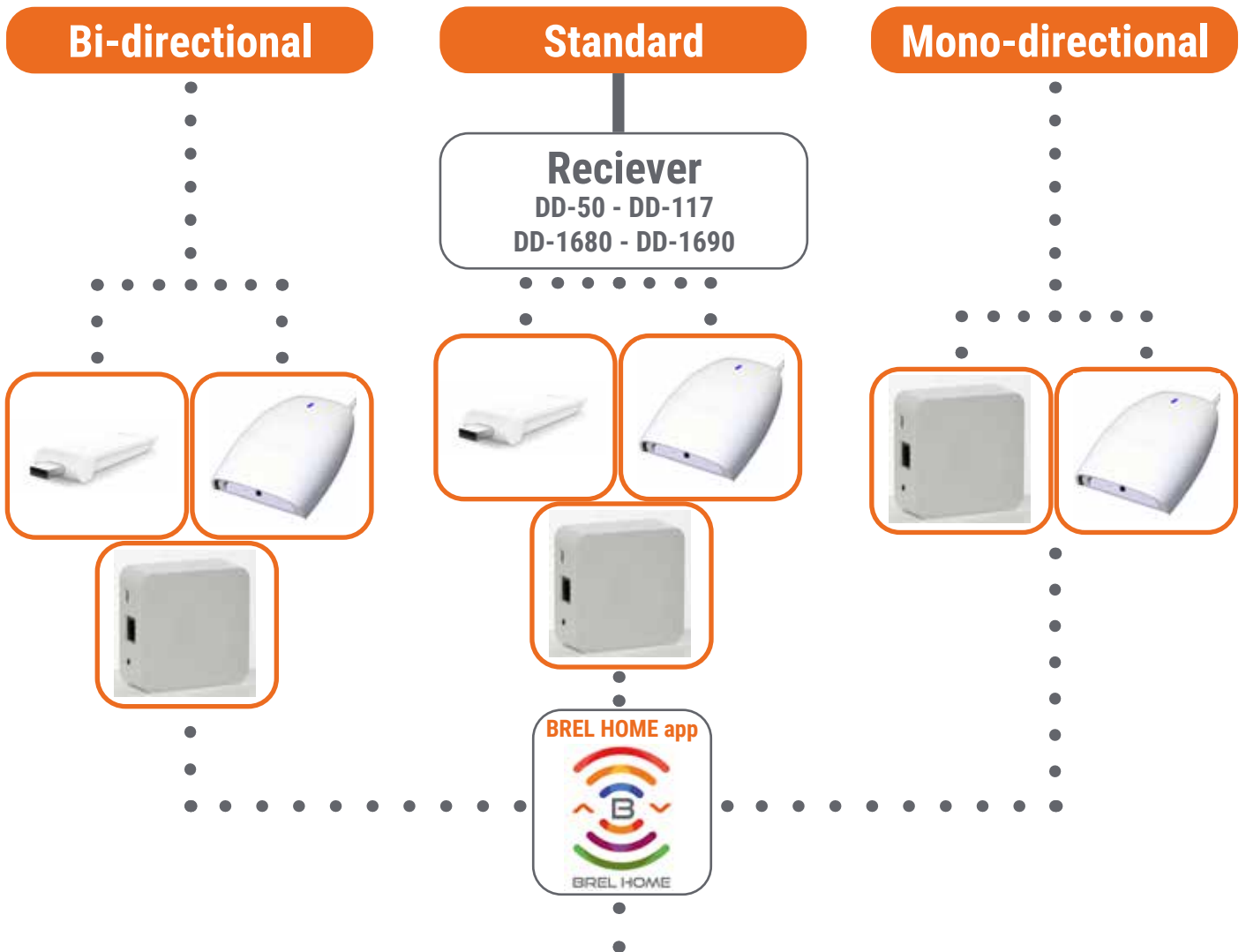

amazon alexa

Google Home

FIBARO

Homey

Home Assistant

Siri



Control with a Home Automation system

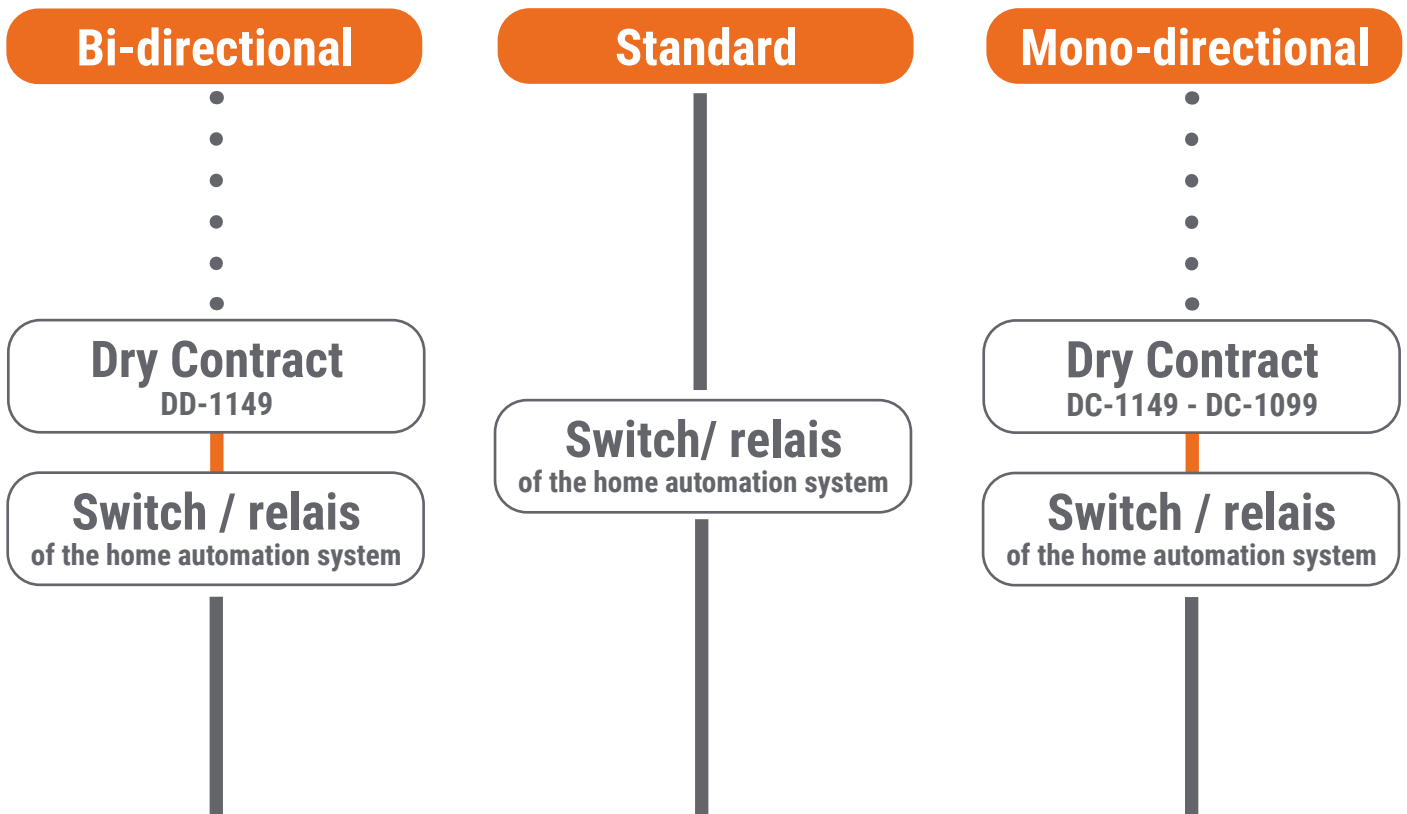

And all other Home Autmation Systems



Protocol

The Brel radio protocol

In 2020, Brel introduced new motors with a protocol for bi-directional communication. This means that the motor communicates the exact status of the product. Another advantage is that Bi-directional motors are much easier to install. The protocol is also more reliable and safer.

The remotes that work with the Bi-directional motors can be recognized by the first letters of the article number, **DD**. Some remotes also work with the motors with the old protocol, for that they have to be put in the correct mode. There are also remote controls available that only work with the old protocol, these article numbers start with **DC**.

The motors can also be controlled with home automation systems.



Warrenty

Brel motors are developed according our ideas and standards. In our factories, these products are very carefully assambled and checked on various points such as torque, noise, voltage (tension), earth, end-limits, brake etc. Our motors undergo a life cycle test for a minimum of 10.000 cycli.

Therefore we give a warrenty of 5 years.

Consumable parts such as remotes, receivers and batteries, are covered by a 1 year limited warrenty. For built-in Li-ion batteries the warrenty has been extended to 5 years.

For further details, please check our terms and conditions, especially article nr. 12.





Calculation & Power Table

How to calculate

Formula used:

$$P \text{ (Nm)} = \text{Radius (mm)} \times G / 100 / (1-V) \text{ (G=Load in kg, Radius in mm diameter tube/ 2 en V =Safety factor)}$$

Formula:

$$\text{Torque (Nm)} = \text{Radius (mm)} \times G \text{ (kg)} / 100 / (1-V)$$

G = Load

V = safety factor = 30%

R= diameter tube

Torque(Nm)	0,3	0,5	0,6	0,8	1,1	1,5	2	3
20	2,1	3,5	4,2	5,6				
25	1,7	2,8	3,4	4,5				
30	1,4	2,3	2,8	3,7	5,2	7,0		
40		1,8	2,1	2,8	3,9	5,3	7,0	10,5
50		1,4	1,7	2,3	3,1	4,2	5,6	8,4
60					1,4	3,5	4,7	7
70							4	6
78								5,4
85								
100								
110								
120								

Calculation & Power Table

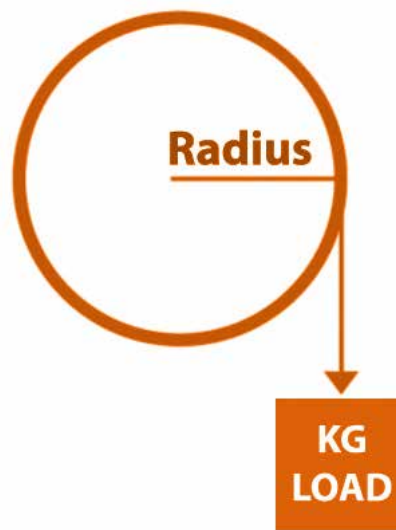

6	10	13	20	30	40	60	80	120	300
21	35	45,5							
16,8	28	36,4							
14	23,3	30,3	46,7	70	93,3				
12	20	26	40	60	80				
10,8	18	23	35,9	53,8	71,8	107,7	143,6	215,4	
						98,8	131,8	197,6	
						84	112	168	420
							101,8	152,7	381,8
							93,3	140	350



Shipping

For shipping packages, the following rates apply in NL

Up to 20 kg	€8,50
Up to 30 kg	€12,50
Pallet	€75,00
Franco at home	NL > €1500,00

For shipping packages international the following rates apply for every 30 kg

Belgium/ Germany	€17,50
Pallet Belgium	€110,00
Poland	€20,00
France/ Denmark/ Austria/ Ireland/ Italy/ Czech/ Portugal	€27,00
Spain/ Lithuania	€35,00
Swiss	€40,00
Outside Europe	Recalculation based on weight and dimensions

Separate rules apply to curtain rails with regard to the length.
> 275 cm = 45,00 in NL and BE.

Shipping costs are exclusive of VAT and no discounts are given.

Outside Holland, deliveries ex-works Brel Doetinchem.

Please email all orders to order@brel-home.com



Notes

A series of horizontal dotted lines for writing notes.



Terms and Conditions

Article 1 - Definitions

1. In these general terms and conditions, the following definitions are used in the following sense, unless explicitly stated otherwise:
2. Offer: Any written offer to the Purchaser for the delivery of Products by the Seller to which these terms and conditions are inseparably linked.
3. Company: The natural or legal entity/person who practices a profession or operates a business.
4. Purchaser: The Company that enters into an Agreement (remotely) with the Seller.
5. Agreement: The sales agreement (entered into remotely) for the sale and delivery of Products bought by the Purchaser from Brel Nederland.
6. Products: The Products offered by Brel Nederland are motors and components for indoor and outdoor sun shades and related products, which include remote controls.
7. Seller: The provider of the Products to the Purchaser, hereinafter referred to as: Brel Nederland.

Article 2 - Applicability

1. These general terms and conditions apply to every Offer made by Brel Nederland and every Agreement between Brel Nederland and a Purchaser, and to every Product offered by Brel Nederland.
2. Before an agreement is entered into (remotely), the Purchaser shall be furnished with these general terms and conditions. If this is not reasonably possible, Brel Nederland shall inform the Purchaser as to how the General Terms and Conditions can be consulted, which will in any event be published on the website of Brel Nederland, so that the Purchaser can conveniently save these General Terms and Conditions on a permanent data medium.
3. In exceptional situations, exceptions to these general terms and conditions may be made if this has been explicitly agreed in writing with Brel Nederland.
4. These general terms and conditions also apply to any supplementary, amended or follow-up agreements with the Purchaser. Any eventual general and/or purchasing conditions set by the Purchaser will be rejected out of hand.
5. If one or more provisions of these general terms and conditions should be wholly or partially voided or annulled, the other provisions of these general terms and conditions shall remain in force and the voided or nullified provision(s) shall be replaced by a provision that has the same purport as the original provision.
6. Any ambiguities regarding the content, explanation or situations that have not been covered in these general terms and conditions must be assessed and clarified in accordance with the spirit of these general terms and conditions.
7. If these general terms and conditions refer to she/he, this should also be understood as a reference to he/she/they, if and insofar as applicable.

Article 3 - The Offer

1. All Offers made by Brel Nederland are non-binding, unless expressly stated otherwise in writing. If the Offer is limited or valid under specific conditions, this shall be expressly stated in the Offer. An Offer shall only be deemed valid once it has been confirmed in writing.
2. Brel Nederland shall submit the Offer by way of a price list. Brel Nederland shall only be bound by the Offer if this is accepted by the Purchaser in writing within the period of validity of the price list, or if the Purchaser has already paid the amount due. Nevertheless, Brel Nederland reserves the right to reject an agreement with a potential Purchaser on the grounds of a justifiable reason for Brel Nederland.
3. The Offer contains an accurate description of the Product on offer together with the corresponding prices. The description is described in such detail as to enable the Purchaser to make a proper assessment of the Offer. Any obvious mistakes or errors in the Offer are not binding to Brel Nederland. Any images and specific data in the Offer only constitute an indication and cannot be grounds for any compensation or the dissolution of the (remote) Agreement. Brel Nederland cannot guarantee that the colours in the images correspond exactly to the actual colours of the Product.
4. Delivery times and deadlines stated in the Offer by Brel Nederland are indicative only, and if exceeded shall not entitle the Purchaser to the dissolution of the Agreement or to compensation, unless expressly agreed otherwise.
5. A combined quote does not obligate Brel Nederland to deliver part of the items included in the bid or Offer in exchange for part of the price quoted.

Article 4 - Conclusion of the Agreement

1. The agreement is concluded the moment the Purchaser has accepted an offer made by Brel Nederland by placing an order with Brel Nederland via email and Brel Nederland has confirmed this order.
2. An Offer can be made by Brel Nederland via a client-specific discount on the gross price list of Brel Nederland or via a client-specific net price.
3. If the terms of acceptance differ (on minor points) from the Offer, Brel Nederland is not bound by these terms.
4. Brel Nederland is not bound by an offer if the Purchaser might have in all reasonableness understood or ought to have understood that the offer clearly contains a mistake or an error in its wording. The Purchaser cannot claim any rights based on this mistake or error.
5. The right of withdrawal is not applicable to the Purchaser.
6. Products which cannot be returned (due to customisation and suchlike) are excluded from the right of withdrawal. This is explicitly stated in the Offer.
7. If the Offer from Brel Nederland is revised due to market circumstances, Brel Nederland has, in consultation, the right to revise or withdraw the Offer.

Article 5 - Execution of the Agreement

1. Brel Nederland will carry out the Agreement to the best of its professional judgement and ability.
2. If and insofar as required for the proper fulfilment of the agreement, Brel Nederland reserves the right to have specific work carried out by third parties at its own discretion.
3. The Purchaser will ensure that Brel Nederland is provided promptly with all the information that Brel Nederland has indicated is necessary, or that the Purchaser should understand within reason what is necessary for fulfilling the Agreement. If the information required for the fulfilment of the agreement is not provided to Brel Nederland in time, Brel Nederland reserves the right to suspend fulfilment of the agreement.
4. In fulfilling the agreement, Brel Nederland is under no obligation or liability to follow the instructions given by the Purchaser if this results in any change to the content or scope of the agreement. If the instructions lead to more work for Brel Nederland, the Purchaser is obligated to reimburse any additional or incidental incurred expenses accordingly.
5. Brel Nederland is entitled to request either a deposit or full payment in advance from the Purchaser before proceeding to fulfil the Agreement.
6. Brel Nederland shall not be held liable for any damage, irrespective of its nature, resulting from the fact that Brel Nederland acted on inaccurate and/or incomplete information provided by the Purchaser, unless Brel Nederland had been aware of this inaccuracy or incompleteness.
7. The Purchaser shall indemnify Brel Nederland against any claims made by third parties who incur damage attributable to the Purchaser in connection with the fulfilment of the agreement.

Article 6 - Delivery

1. If the commencement, progress or delivery of the agreement is delayed because, for instance, the Purchase has failed to provide all requested information or has failed to do so on time, or has failed to cooperate sufficiently, or if the advance/payment has not been received on time by Brel Nederland, or if there is any delay as a result of other circumstances beyond Brel Nederland's control, Brel Nederland reserves the right to extend the delivery period by a reasonable amount of time. All delivery deadlines agreed upon do not constitute fixed deadlines. The Purchaser must notify Brel Nederland in writing of any default on their part and allow Brel Nederland a reasonable time frame in order to be able to still fulfil its obligations. The Purchaser is not eligible for any compensation as a result of the delay.
2. The Purchaser is obligated to take delivery of the goods at the time they are made available to them in accordance with the Agreement, and also if they are offered to them earlier or later than agreed.
3. If the Purchaser refuses to take delivery or fails to provide information or instructions necessary for the delivery, Brel Nederland reserves the right to store the goods at the Purchaser's expense and risk.
4. If the Products are delivered by Brel Nederland or an external haulier, Brel Nederland is entitled, unless otherwise agreed in writing, to charge for delivery costs. These costs will be invoiced separately, unless expressly agreed otherwise.
5. If Brel Nederland needs information from the Purchaser for the purpose of fulfilling the agreement, the delivery period shall not commence until the Purchaser has provided Brel Nederland with all the information required for fulfilment of the agreement.
6. Any delivery period specified by Brel Nederland is intended to be indicative only. Longer delivery periods apply to deliveries outside of the Netherlands.
7. Brel Nederland reserves the right to deliver the goods in part shipments, unless this has been agreed otherwise or the partial delivery is not considered to have any independent value. Therefore, Brel Nederland is entitled to submit a separate invoice for the goods delivered in this way.
8. Brel Nederland can stipulate that delivery will only take place if all invoices have been paid, if there are well-founded concerns about the risk of non-payment.



Terms and Conditions

Article 7 - Packaging and transport

1. In respect of the Purchaser, Brel Nederland undertakes to package the goods to be delivered properly and to secure them in such a way that they will reach their destination in good condition under normal conditions of handling.
2. Unless otherwise agreed in writing, all deliveries are to include Value Added Tax (VAT), including packaging and packaging materials.
3. Acceptance of goods without any notes or comments on the consignment form or on the receipt shall be considered proof that the packaging was in good condition at the time of delivery.

Article 8 - Inspections, claims

1. The Purchaser is obligated to inspect (or arrange to have inspected) the Products delivered at the time of delivery, but in any event, within 7 days of receipt of the Products, and only to unpack or use these insofar as is strictly necessary in order to be able to assess whether it holds the Product. In doing so, the Purchaser should check whether the quality and quantity of the goods delivered is in accordance with the Agreement and the Products meet the requirements that apply to normal (business) transactions.
2. The Purchaser is under the obligation to check and inform themselves as to how the Product should be used, and in the case of personal use, to test the Product according to the instructions for use. Brel Nederland does not accept any liability for incorrect use of the Product by the Purchaser.
3. Any eventual noticeable defects or missing parts after delivery must be notified in writing to Brel Nederland at order@brel-home.com. The Purchaser has a period of 7 days after delivery to do this. Any non-visible defects or missing parts must be reported within 7 days of their detection, but no later than 6 months after delivery. If the Product is damaged as a result of careless handling by the Purchaser, the Purchaser is personally liable for any depreciation in the value of the Product.
4. If a claim is submitted in time under the provisions of the previous paragraph, the Purchaser shall remain under obligation to pay for the purchased goods. If the Purchaser wishes to return defective goods, they must do so exclusively with the prior written permission of Brel Nederland, in the manner specified by Brel Nederland.
5. The direct costs of return shipments shall be borne by the Purchaser.
6. Brel Nederland reserves the right to launch an investigation into the authenticity and condition of the returned Products before a refund is made.
7. Refunds to the Purchaser will be processed as quickly as possible, but may take up to 30 days after receipt of the returned shipment. Refunds shall be made to the previously specified account number.
8. If the Seller exercises their right to make a claim, they will not be entitled to suspend their payment obligation or to offset outstanding invoices.
9. If delivery is not made in full, and/or if one or more Products are missing, and this is the fault of Brel Nederland, Brel Nederland will, at the Purchaser's request, send the missing Product(s) or cancel the remaining order. The confirmation of the receipt of the Products is a decisive factor in this. Any damage sustained by the Purchaser as a result of the (deviating) scope of the delivery cannot be recouped from Brel Nederland.

Article 9 - Prices

1. During the validity period of the price list, the prices of the Products on offer will not be raised, except in the event of major fluctuations in market prices, currency or transport. The Purchaser will be informed of this in good time.
2. The prices stated in the Offer are exclusive of VAT, unless explicitly stated otherwise.
3. The prices stated in the Offer are based on the cost factors applicable at the time the Agreement is concluded, such as: import and export duties, freight and unloading costs, insurance and any levies and taxes.
4. In the event that Products or raw materials are subject to price fluctuations on the financial market over which Brel Nederland has no influence, Brel Nederland reserves the right to offer these Products at variable prices. It will then be stated in the Offer that the prices are indicative prices and may be subject to change.

Article 10 - Payment and debt collection policy

1. Payment must be made subsequently in the currency of the invoice by the method indicated within the term of payment stated on the invoice.
2. The Purchaser cannot claim any rights or expectations on an estimate issued in advance, unless the parties have explicitly agreed otherwise.
3. The Purchaser must arrange for payment to be made in one instalment to the account number and details of Brel Nederland as indicated to them. The parties may only agree on different payment terms after receiving express written permission from Brel Nederland.
4. If a periodic payment obligation on the part of the Purchaser has been agreed to, Brel Nederland reserves the right to revise the applied prices and rates in writing, with due observance of a period of 3 months.
5. In the event of the winding-up, bankruptcy, seizure or suspension of payment by the Purchaser, the amounts receivable by Brel Nederland from the Purchaser are due immediately.
6. Brel Nederland has the right to first allocate payments made by the Purchaser to the deduction of costs, then to the deduction of interest owed, and finally to the deduction of the principal sum and the accrued interest. Brel Nederland may, without thereby falling into default, refuse an offer of payment if the Purchaser proposes a different sequence of allocation. Brel Nederland may refuse full payment of the principal sum, if the outstanding and accrued interest, together with the expenses, have also not been paid.
7. If the Purchaser fails to meet their payment obligations and has not made payment within the stipulated period of 30 days, the Purchaser will be in default.
8. From the date on which the Purchaser defaults, Brel Nederland shall, without further notice, claim the statutory (commercial) interest from the first day of default until full payment and compensation for any out-of-court legal expenses in accordance with Article 6:96 of the Dutch Civil Code, to be calculated according to the sliding scale set out in the Decree on compensation for out-of-court debt collection costs dated 1 July 2012.
9. If Brel Nederland has incurred more or higher costs that are necessary within reason, such costs will be eligible for compensation. The Purchaser is also liable for any legal and execution expenses incurred.

Article 11 - Retention of title

1. All goods delivered by Brel Nederland shall remain the property of Brel Nederland until the Purchaser has fulfilled all of their obligations under all Agreements entered into with Brel Nederland.
2. The Purchaser is not entitled to pledge the goods that fall under the retention of title or to claim any other rights if ownership has not yet been transferred in full.
3. If third parties seize goods that have been delivered and are subject to retention of title, or wish to exercise or claim rights over these goods, the Purchaser is under the obligation to inform Brel Nederland of this as soon as can reasonably be expected.
4. In the event that Brel Nederland seeks to exercise its retention of title as set out in this article, the Purchaser hereby grants unconditional and irrevocable permission and authority to Brel Nederland or third parties appointed by Brel Nederland to access all sites and locations where Brel Nederland's property is located and to recover such items.
5. Brel Nederland is entitled to retain the Product(s) purchased by the Purchaser if the Purchaser has not yet (fully) complied with their payment obligations, irrespective of any obligation on the part of Brel Nederland to deliver or hand over the Products. After the Purchaser has fulfilled their obligations, Brel Nederland shall make every effort to deliver the purchased Products to the Purchaser as soon as possible, but within 20 working days at the latest.
6. Any expenses and other (consequential) damages as a result of holding onto the purchased Products shall be at the expense and risk of the Purchaser and shall be reimbursed by the Purchaser to Brel Nederland upon the first request.

Article 12 - Warranty

1. Brel Nederland guarantees that the Products comply with the Agreement, the specifications listed in the Offer, as well as their suitability and/or soundness and the applicable statutory rules/regulations at the time of the conclusion of the Agreement. This also applies if the goods to be delivered are intended for use abroad and the Purchaser has expressly notified the Seller of this use in writing at the time of entering into the Agreement.
2. The warranties on the Products supplied by Brel Nederland comprise:
A 5-year guarantee is issued for motors with or without an integrated battery. Related Products that, in the opinion of Brel Nederland, are susceptible to wear and tear, such as transmitters, receivers, controllers, rechargeable batteries and batteries, are covered by a 1-year warranty.
3. The warranty given by Brel Nederland can only be claimed if the Purchaser has fully met all of their payment obligations.
4. If the Purchaser is justified in making a claim under an agreed warranty, Brel Nederland shall be obliged to repair or replace the Products free of charge.
5. The warranty will become null and void as soon as the warranty period has expired, or the Purchaser themselves makes alterations to the Products or has them made.



Terms and Conditions

Article 13 - Suspension and dissolution

1. Brel Nederland is entitled to suspend fulfilment of its obligations or to dissolve the Agreement if the Purchaser fails to fulfil their (payment) obligations under the Agreement or fails to do so in full.
2. Furthermore, Brel Nederland is within its rights to dissolve, without any legal intervention, the Agreement between Brel Nederland and the Purchaser, insofar as this Agreement has not yet been fulfilled, if the Purchaser does not fulfil, or does not fulfil on time or in a satisfactory manner, the obligations that fall on them pursuant to any Agreement entered into with Brel Nederland.
3. In addition to the above, Brel Nederland is within its rights to dissolve the Agreement (or have it dissolved) without prior notice of default if circumstances arise of such a nature that fulfilment of the Agreement becomes impossible or can no longer be required on the grounds of fairness and reasonableness, or if any other circumstances arise of such a nature that the nonamended continuation of the Agreement may not be expected in all reasonableness.
4. If the Agreement is dissolved, the amounts receivable by Brel Nederland from the Purchaser shall become immediately due and payable. If Brel Nederland suspends fulfilment of its obligations, it shall retain its rights under the law and the Agreement.
5. Brel Nederland reserves the right to claim compensation for damages at all times.

Article 14 - Limitation of liability

1. If the fulfilment of the agreement by Brel Nederland gives rise to liability on the part of Brel Nederland vis-à-vis the Purchaser or third parties, such liability shall be limited to the costs borne by Brel Nederland related to the Agreement, unless the damage is due to wilful misconduct or gross negligence. In all cases, the liability of Brel Nederland shall be limited to the maximum amount paid out by the insurance company per incident per year.
2. Brel Nederland shall not be held liable for any consequential damage, indirect damage, loss of profits and/or incurred losses, missed savings and damage as a result of the use of the supplied Products are hereby excluded.
3. Brel Nederland is not liable for and/or under any obligation to repair damage that is caused by the use of the Product. Brel Nederland provides strict maintenance and instructions for usage that must be followed up by the Purchaser. Any damages to Products resulting from carrying them around and using them are expressly excluded from any liability (defined as: damage due to use, dropping, light and water damage, theft, disappearance etc).
4. Brel Nederland will not be held liable for any damage which is or may be the result of any act or omission as a consequence of (incomplete and/or incorrect) information on the website(s) or on linked websites.
5. Brel Nederland is not responsible for any errors and/or discrepancies in the functionality of the website and is not liable for any disruptions or unavailability of the website for whatever reason.
6. Brel Nederland can neither vouch for the correct and complete transmission of the content of emails sent by/on behalf of Brel Nederland, nor for their timely receipt.
7. All claims from the Purchaser due to any failure on the part of Brel Nederland shall become null and void if not reported to Brel Nederland in writing, stating reasons, within one year after the Purchaser became aware or could reasonably have become aware of the facts on which it bases its claims. All claims on the part of the Purchaser shall in all cases be null and void one year following the termination of the Agreement.

Article 15 - Force majeure

1. Brel Nederland shall not be held liable if it is unable to fulfil its obligations under the Agreement due to circumstances beyond its control (Force Majeure), nor can it be compelled to fulfil any obligation if it is prevented from doing so as a result of a circumstance that is not its fault and for which it cannot be held accountable under the law, a legal action or common practice.
2. Force majeure is understood to mean in all cases, but is not limited to, under the provisions of the law and jurisprudence, (i) circumstances beyond the control of suppliers to Brel Nederland, (ii) failure to properly fulfil obligations by suppliers that have been prescribed or recommended to Brel Nederland by the Purchaser, (iii) defectiveness of goods, equipment, software or materials from third parties, (iv) government measures, (v) electricity failures, (vi) disruption of the internet, data network and telecommunication facilities (e.g. as a result of cybercrime and hacking), (vii) natural disasters, (viii) war and terrorist attacks, (ix) general transport problems, (x) industrial action at the company of Brel Nederland and (xi) other situations which, in the judgement of Brel Nederland, are beyond its control and which temporarily or permanently prevent the fulfilment of its obligations.
3. Brel Nederland has the right to claim force majeure if the circumstance preventing (further) fulfilment of its obligations occurs after Brel Nederland should have fulfilled its obligation.
4. Parties may suspend their obligations under the Agreement during the time that the force majeure lasts. If this period lasts longer than two months, either party is entitled to dissolve the Agreement without any obligation to pay the other party compensation for damages.
5. Insofar as Brel Nederland has already partially fulfilled its obligations under the Agreement at the time when circumstances beyond its control arise, or will be able to fulfil them, and that part which has been or will be fulfilled has an independent value, Brel Nederland is entitled to separately invoice the part already fulfilled, or which will be fulfilled. The Purchaser is obliged to pay this invoice as if it were a separate Agreement.

Article 16 - Transfer of risk

The risk of loss of or damage to the Products that are covered by the Agreement shall pass to the Purchaser from the moment the goods leave the warehouse of Brel Nederland.

Article 17 - Intellectual Property Rights

1. All intellectual property rights and copyrights of Brel Nederland are held exclusively by Brel Nederland and are not transferable to the Purchaser.
2. The Purchaser is prohibited from disclosing and/or reproducing, altering or making available to third parties any items covered by the intellectual property rights and copyrights of Brel Nederland without the express prior written consent of Brel Nederland. If the Purchaser wishes to make any changes to goods delivered by Brel Nederland, Brel Nederland must give its express consent to the proposed changes.
3. The Purchaser is not permitted to use the Products covered by the intellectual property rights of Brel Nederland in any way other than as agreed upon in the Agreement.
4. Any infringement by the Purchaser of the IP rights of Brel Nederland shall be penalised by a one-off fine to the sum of €10,000 and a fine of €500 for each day that the infringement continues. This penalty clause does not affect the right of Brel Nederland to claim damages.

Article 18 - Privacy, data processing and security

1. Brel Nederland will treat the (personal) data of the Purchaser and visitors to the website(s) with the utmost care. Consequently, if requested, Brel Nederland will inform the party concerned about what this entails.
2. If, on the grounds of the Agreement, Brel Nederland is required to provide security for any information, said security must comply with the agreed specifications and must be of a security level that is not unreasonable in view of the state of the technology, the sensitivity of the data and the costs involved.

Article 19 - Complaints

1. If the Purchaser is not satisfied with the Products supplied by Brel Nederland and/or has complaints about the (execution of the) Agreement, the Purchaser is under the obligation to report these complaints as soon as possible, but no later than within 14 working days of the relevant incident leading to the complaint. Complaints can be submitted to order@brel-home.com under the subject "Complaint."
2. The complaint must be adequately substantiated and/or accompanied by an explanation on the part of the Purchaser in order for Brel Nederland to be able to handle the complaint.
3. Brel Nederland will respond to the complaint as soon as possible, but no later than 14 calendar days after receiving it.
4. The parties shall attempt to reach a solution together.

Article 22 - Applicable law

1. All agreements between Brel Nederland and the Purchaser are governed by Dutch law. Applicability of the Vienna Sales Convention (CISG) is expressly excluded.
2. The Dutch text of these general terms and conditions shall prevail over any interpretation of their content and scope. Brel Nederland reserves the right to unilaterally amend these general terms and conditions.
3. All disputes arising from or as a result of the Agreement between Brel Nederland and the Purchaser will be settled by the competent court in Gelderland, location Zutphen, unless provisions of mandatory law result in the jurisdiction of another court.



BREL HOME

Voltastraat 86
7006 RW Doetinchem
0314-680448
info@brel-home.com

KVK: 51486873
BTW nr: NL850046592B01
IBAN nr: NL59 RABO 0148 1296 33
BIC code: RABONL2U